

EU DECLARATION OF CONFORMITY

**DEVICE
817.600
BIGRIG**

ACCORDING TO STANDARDS

RfU PPE-R/11.114 VI:2018

Tested also according to

EN 795:2012 type A

CEN TS 16415:2013 type A

(max 2 users at time)

Tested as support for suitable

winches according to

EN1496:2017 class B

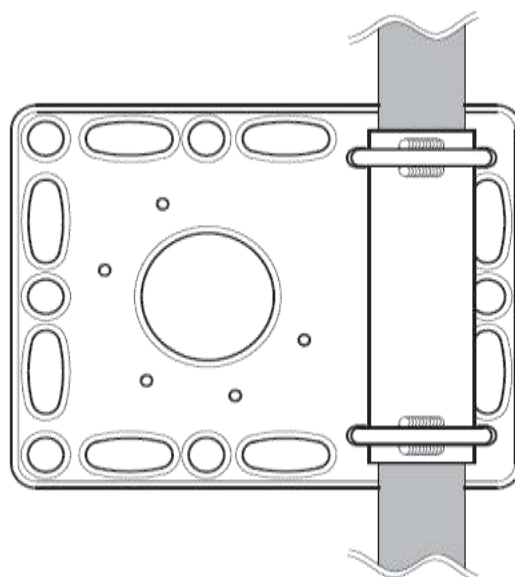

Certified by the Notified Body:

n° 0123 - TÜV SÜD Product Service GmbH - Ridlerstraße 65, 80339 Munich, Germany

With the certificate P5A 023385 0237 Rev. 00

Date of the document 19/10/2020

Italiano

Dichiarazione di Conformità UE

La presente Dichiarazione di Conformità è rilasciata sotto l'esclusiva responsabilità del fabbricante:

KONG S.p.A. – Via XXV Aprile, 4 – 23804 Monte Marenzo LC – Italia

Il Dispositivo di Protezione Individuale (DPI)

817.600 BIGRIG

oggetto della dichiarazione è conforme al Regolamento (UE) 2016/425 e alle normative di armonizzazione dell'Unione Europea:

RfU PPE-R/11.114 V1:2018

Tested also according to

EN 795:2012 type A

CEN TS 16415:2013 type A

(max 2 users at time)

Tested as support for suitable

winches according to

EN1496:2017 class B

L'organismo notificato

n° 0123 - TÜV SÜD Product Service GmbH - Ridlerstraße 65, 80339 Munich, Germany

ha svolto l'esame UE del tipo (modulo B) e ha rilasciato il certificato di esame UE del tipo:

P5A 023385 0237 Rev. 00

Il DPI è oggetto della procedura di valutazione delle conformità al tipo basata sulla garanzia di qualità del processo di produzione (modulo D) sotto la sorveglianza dell'organismo notificato n. 0426 Italcert (Viale Sarca 336, 20126 Milano (MI), Italy).

Monte Marenzo, 19/10/2020

KONG S.p.A.

Il Presidente

Dr. Marco Bonaiti

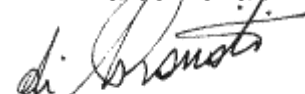

English

EU Declaration of Conformity

This Declaration of Conformity is issued under the exclusive responsibility of the manufacturer:

KONG S.p.A. – Via XXV Aprile, 4 – 23804 Monte Marenzo LC – Italia

The Personal Protective Equipment (PPE)

817.600 BIGRIG

subject to the declaration complies with Regulation (EU) 2016/425 and with European Union harmonisation standards:

RfU PPE-R/11.114 V1:2018

Tested also according to

EN 795:2012 type A

CEN TS 16415:2013 type A

(max 2 users at time)

Tested as support for suitable

winches according to

EN1496:2017 class B

The notified body

n° 0123 - TÜV SÜD Product Service GmbH - Ridlerstraße 65, 80339 Munich, Germany

Has performed the EU examination for the type (module B), and has issued an EU examination certificate for the type:

P5A 023385 0237 Rev. 00

The PPE is subject to the type conformity assessment procedure, based on the quality assurance of the production process (module D), under surveillance by the notified body n° 0426 Italcert (Viale Sarca 336, 20126 Milano (MI), Italy).

Monte Marenzo, 19/10/2020

KONG S.p.A.
The president

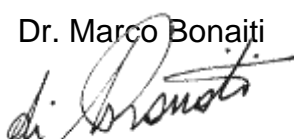
Dr. Marco Bonaiti

Français

Déclaration de conformité UE

La présente Déclaration de Conformité est délivrée sous la responsabilité exclusive du Fabricant:

KONG S.p.A. – Via XXV Aprile, 4 – 23804 Monte Marenzo LC – Italia

L'Équipement de Protection Individuelle (EPI)

817.600 BIGRIG

objet de la déclaration est conforme au Règlement (UE) 2016/425 et aux normes d'harmonisation de l'Union Européenne:

RfU PPE-R/11.114 V1:2018

Tested also according to

EN 795:2012 type A

CEN TS 16415:2013 type A

(max 2 users at time)

Tested as support for suitable

winches according to

EN1496:2017 class B

L'organisme notifié

n° 0123 - TÜV SÜD Product Service GmbH - Ridlerstraße 65, 80339 Munich, Germany

a effectué l'examen UE de type (module B) et a délivré le certificat d'examen UE de type:

P5A 023385 0237 Rev. 00

L'EPI est soumis à la procédure d'évaluation de conformité au type sur la base de l'assurance de la qualité du mode de production (module D) sous la supervision de l'organisme notifié n° 0426 Italcert (Viale Sarca 336, 20126 Milano (MI), Italy).

Monte Marenzo, 19/10/2020

KONG S.p.A.
Le Président

Dr. Marco Bonaiti

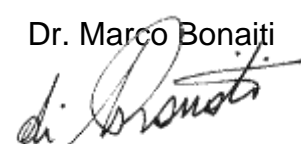



Deutsch

EU-Konformitätserklärung

Die vorliegende Konformitätserklärung wird unter der alleinigen Verantwortung des Herstellers ausgestellt:

KONG S.p.A. – Via XXV Aprile, 4 – 23804 Monte Marenzo LC – Italia

Die persönliche Schutzausrüstung (PSA)

817.600 BIGRIG

Gegenstand dieser Erklärung, entspricht der EU-Verordnung 2016/425 sowie den harmonisierten Normen der Europäischen Union:

RfU PPE-R/11.114 V1:2018

Tested also according to

EN 795:2012 type A

CEN TS 16415:2013 type A

(max 2 users at time)

Tested as support for suitable

winches according to

EN1496:2017 class B

Die benannte Stelle

n° 0123 - TÜV SÜD Product Service GmbH - Ridlerstraße 65, 80339 Munich, Germany

hat die EU-Baumusterprüfung (Modul B) durchgeführt und die EU-Baumusterprüfbescheinigung ausgestellt:

P5A 023385 0237 Rev. 00

Die PSA ist Gegenstand der Konformitätsbewertung anhand der Baumusterprüfung auf der Grundlage einer Qualitätssicherung des Produktionsprozesses (Modul D) unter der Überwachung durch die benannte Stelle Nr. 0426 Italcert (Viale Sarca 336, 20126 Milano (MI), Italy).

Monte Marenzo, 19/10/2020

KONG S.p.A.
Der Vorsitzende

Dr. Marco Bonaiti

Español

Declaración de conformidad UE

La presente Declaración de Conformidad se expide bajo la exclusiva responsabilidad del fabricante:

KONG S.p.A. – Via XXV Aprile, 4 – 23804 Monte Marenzo LC – Italia

El Equipo de Protección individual (EPI)

817.600 BIGRIG

objeto de la declaración se ajusta al Reglamento (UE) 2016/425 y a las normativas de armonización de la Unión Europea:

RfU PPE-R/11.114 V1:2018

Tested also according to

EN 795:2012 type A

CEN TS 16415:2013 type A

(max 2 users at time)

Tested as support for suitable

winches according to

EN1496:2017 class B

El organismo notificado

n° 0123 - TÜV SÜD Product Service GmbH - Ridlerstraße 65, 80339 Munich, Germany

ha realizado el examen UE de tipo (módulo B) y ha expedido el certificado de examen UE de tipo:

P5A 023385 0237 Rev. 00

El EPI es objeto del procedimiento de evaluación de la conformidad con el tipo basada en el aseguramiento de la calidad del proceso de producción (módulo D) bajo la supervisión del organismo notificado n° 0426 Italcert (Viale Sarca 336, 20126 Milano (MI), Italy).

Monte Marenzo, 19/10/2020

KONG S.p.A.
El Presidente

Dr. Marco Bonaiti

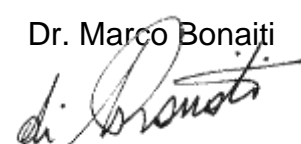

русский

Декларация соответствия ЕС

Настоящая Декларация соответствия выдана под исключительную ответственность производителя:

KONG S.p.A. – Via XXV Aprile, 4 – 23804 Monte Marenzo LC – Italia

Средство индивидуальной защиты (СИЗ)

817.600 BIGRIG

предмет декларации соответствует Регламенту (ЕС) 2016/425 и гармонизированным стандартам Европейского Союза:

RfU PPE-R/11.114 V1:2018

Tested also according to

EN 795:2012 type A

CEN TS 16415:2013 type A

(max 2 users at time)

Tested as support for suitable

winches according to

EN1496:2017 class B

Уполномоченный орган

n° 0123 - TÜV SÜD Product Service GmbH - Ridlerstraße 65, 80339 Munich, Germany

провел испытание типового образца на соответствие требованиям ЕС (модуль B) и выдал сертификат испытаний типового образца на соответствие требованиям ЕС:

P5A 023385 0237 Rev. 00

СИЗ является предметом процедуры оценки соответствия типовому образцу, основанной на обеспечении качества производственного процесса (модуль D) под наблюдением уполномоченного органа № 0426 — органа сертификации Italcert (Viale Sarca 336, 20126 Milano (MI), Italy).

Monte Marenzo, 19/10/2020

KONG S.p.A.
Президент

Dr. Marco Bonaiti

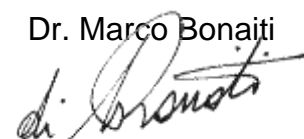

中文

EU符合性声明

本“符合性声明”由以下制造商全权负责发布：

KONG S.p.A. – Via XXV Aprile, 4 – 23804 Monte Marenzo LC – Italia

个人防护装备 (PPE)

817.600 BIGRIG

本声明的目标符合法规 (EU) 2016/425和欧盟统一标准的规定：

RfU PPE-R/11.114 V1:2018

Tested also according to

EN 795:2012 type A

CEN TS 16415:2013 type A

(max 2 users at time)

Tested as support for suitable

winches according to

EN1496:2017 class B

欧盟公告机构

n° 0123 - TÜV SÜD Product Service GmbH - Ridlerstraße 65, 80339 Munich, Germany

进行了欧盟型式检验 (模式B) 并颁发了欧盟型式检验证书：

P5A 023385 0237 Rev. 00

PPE (个人防护装备) 在0426号公告机构Italcert (Viale Sarca 336, 20126 Milano (MI), Italy)的监督下，在生产过程质量保证 (模式D) 的基础上进行合格评定程序。

Monte Marenzo, 19/10/2020

KONG S.p.A.

总裁

Dr. Marco Bonaiti

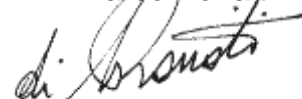

българск

Декларация за съответствие EU

Настоящата Декларация за съответствие се издава под изключителната отговорност на производителя:

KONG S.p.A. – Via XXV Aprile, 4 – 23804 Monte Marenzo LC – Italia

Личното предпазно средство (ЛПС)

817.600 BIGRIG

предмет на настоящата декларация е в съответствие с Регламент (EU) 2016/425 и хармонизираните стандарти на Европейския съюз:

RfU PPE-R/11.114 V1:2018

Tested also according to

EN 795:2012 type A

CEN TS 16415:2013 type A

(max 2 users at time)

Tested as support for suitable

winches according to

EN1496:2017 class B

Нотифицираният организъм

n° 0123 - TÜV SÜD Product Service GmbH - Ridlerstraße 65, 80339 Munich, Germany

е провел изпитване EU за типово одобрение (формуляр „B“) и е издал сертификат за типово одобрение EU:

P5A 023385 0237 Rev. 00

Личното предпазно средство (ЛПС) е предмет на процедура за оценка на съответствието, основаваща се на гаранция на качеството на производствения процес (формуляр „D“) под наблюдението на нотифицирания организъм № 0426 Italcert (Viale Sarca 336, 20126 Milano (MI), Italy).

Monte Marenzo, 19/10/2020

KONG S.p.A.
Председател

Dr. Marco Bonaiti

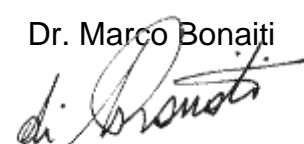

čeština

UE prohlášení o shodě

Toto prohlášení o shodě je učiněno na výhradní zodpovědnost výrobce:

KONG S.p.A. – Via XXV Aprile, 4 – 23804 Monte Marenzo LC – Italia

Osobní ochranný prostředek (OOP)

817.600 BIGRIG

který je předmětem prohlášení, splňuje požadavky nařízení (EU) 2016/425 a harmonizačních právních předpisů Evropské unie:

RfU PPE-R/11.114 V1:2018

Tested also according to

EN 795:2012 type A

CEN TS 16415:2013 type A

(max 2 users at time)

Tested as support for suitable

winches according to

EN1496:2017 class B

Oznámený subjekt

n° 0123 - TÜV SÜD Product Service GmbH - Ridlerstraße 65, 80339 Munich, Germany

provedl UE přezkoušení typu (modul B) a vydal certifikát UE přezkoušení typu:

P5A 023385 0237 Rev. 00

OOP podléhá postupu posouzení shody s typem založené na zajištění jakosti výrobního procesu (modul D) pod dohledem oznámeného subjektu č. 0426 Italcert (Viale Sarca 336, 20126 Milano (MI), Italy).

Monte Marenzo, 19/10/2020

KONG S.p.A.

Předseda

Dr. Marco Bonaiti

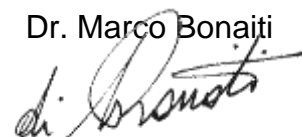

Hrvatski

EU Izjava o sukladnosti

Ova se izjava o sukladnosti izdaje pod isključivom odgovornošću proizvođača:

KONG S.p.A. – Via XXV Aprile, 4 – 23804 Monte Marenzo LC – Italia

Osobna zaštitna oprema (OZO)

817.600 BIGRIG

Predmet izjave u skladu je s Uredbom (EU) 2016/425 i sa zakonodavstvom Unije o usklađivanju:

RfU PPE-R/11.114 V1:2018

Tested also according to

EN 795:2012 type A

CEN TS 16415:2013 type A

(max 2 users at time)

Tested as support for suitable

winches according to

EN1496:2017 class B

Prijavljeno tijelo

n° 0123 - TÜV SÜD Product Service GmbH - Ridlerstraße 65, 80339 Munich, Germany

obavilo je EU ispitivanje tipa (modul B) i izdalo potvrdu o EU ispitivanju tipa:

P5A 023385 0237 Rev. 00

OZO je predmet postupka ocjenjivanja sukladnosti s tipom na temelju osiguranja kvalitete proizvodnog postupka (modul D) pod nadzorom prijavljenog tijela br. 0426 Italcert (Viale Sarca 336, 20126 Milano (MI), Italy).

Monte Marenzo, 19/10/2020

KONG S.p.A.
Direktor

Dr. Marco Bonaiti

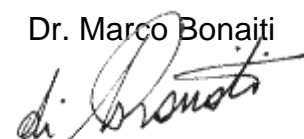

Dansk

EU-overensstemmelseserklæring

Denne overensstemmelseserklæring udstedes på fabrikantens ansvar:

KONG S.p.A. – Via XXV Aprile, 4 – 23804 Monte Marenzo LC – Italia

Det personlige værnemiddel (PPE - PV'er)

817.600 BIGRIG

anført i erklæringen er i overensstemmelse med forordning (EU) nr. 2016/425 og med EU-harmoniseringslovgivningen:

RfU PPE-R/11.114 V1:2018

Tested also according to

EN 795:2012 type A

CEN TS 16415:2013 type A

(max 2 users at time)

Tested as support for suitable

winches according to

EN1496:2017 class B

Det bemyndigede organ

n° 0123 - TÜV SÜD Product Service GmbH - Ridlerstraße 65, 80339 Munich, Germany

har foretaget en EU-typeafprøvning (Modul B) og har udstedt EU-typeafprøvningsattest:

P5A 023385 0237 Rev. 00

Det personlige værnemiddel er genstand for proceduren for typeoverensstemmelse på grundlag af kvalitetssikring af fremstillingsprocessen (modul D) under tilsyn fra det bemyndigede organ nr. 0426 Italcert (Viale Sarca 336, 20126 Milano (MI), Italy).

Monte Marenzo, 19/10/2020

KONG S.p.A.
Formand

Dr. Marco Bonaiti

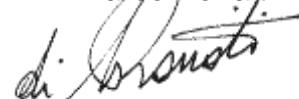

Nederlands

EU-conformiteitsverklaring

Deze conformiteitsverklaring wordt verstrekt op eigen verantwoording van de fabrikant:

KONG S.p.A. – Via XXV Aprile, 4 – 23804 Monte Marenzo LC – Italia

Het persoonlijk beschermingsmiddel (PBM)

817.600 BIGRIG

voorwerp van deze verklaring, voldoet aan de Verordening (EU) 2016/425 en de harmonisatiewetgeving van de Europese Unie:

RfU PPE-R/11.114 V1:2018

Tested also according to

EN 795:2012 type A

CEN TS 16415:2013 type A

(max 2 users at time)

Tested as support for suitable

winches according to

EN1496:2017 class B

De aangemelde instantie

n° 0123 - TÜV SÜD Product Service GmbH - Ridlerstraße 65, 80339 Munich, Germany

heeft het EU-typeonderzoek (module B) verricht en het certificaat van EU-typeonderzoek afgegeven:

P5A 023385 0237 Rev. 00

Het PBM is onderworpen aan de conformiteitsbeoordelingsprocedure met het type op basis van kwaliteitsborging van het productieproces (module D) onder toezicht van de aangemelde instantie Italcert nr. 0426 (Viale Sarca 336, 20126 Milano (MI), Italy).

Monte Marenzo, 19/10/2020

KONG S.p.A.

De voorzitter

Dr. Marco Bonaiti

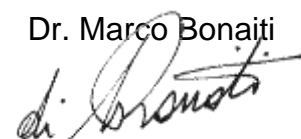

Eesti

EL-i vastavusdeklaratsioon

See vastavusdeklaratsioon on välja antud järgmise tootja ainuvastutusel:

KONG S.p.A. – Via XXV Aprile, 4 – 23804 Monte Marenzo LC – Italia

Isikukaitsevahend

817.600 BIGRIG

vastavusdeklaratsiooniga hõlmatud isikukaitsevahend vastab määrusele (EL) 2016/425 ja Euroopa Liidu ühtlustamisõigusaktidele:

RfU PPE-R/11.114 V1:2018

Tested also according to

EN 795:2012 type A

CEN TS 16415:2013 type A

(max 2 users at time)

Tested as support for suitable

winches according to

EN1496:2017 class B

Teavitatud asutus

n° 0123 - TÜV SÜD Product Service GmbH - Ridlerstraße 65, 80339 Munich, Germany

on teinud tüübihindamise (moodul B) ja väljastanud tüübihindamissertifikaadi:

P5A 023385 0237 Rev. 00

Isikukaitsevahendile kohaldatakse tootmiskvaliteedi tagamisel põhinevat tüübivastavuse hindamise menetlust (moodul B) teavitatud asutuse 0426 Italcert (Viale Sarca 336, 20126 Milano (MI), Italy) järelevalve all.

Monte Marenzo, 19/10/2020

KONG S.p.A.

Esimees

Dr. Marco Bonaiti

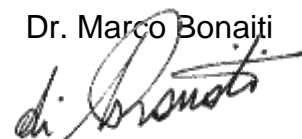

Suomi

EU-vaatimustenmukaisuusvakuutus

Tämä vaatimustenmukaisuusvakuutus on annettu valmistajan yksinomaisella vastuulla:

KONG S.p.A. – Via XXV Aprile, 4 – 23804 Monte Marenzo LC – Italia

Vakuutuksen kohteena oleva henkilönsuojain

817.600 BIGRIG

on neuvoston asetuksen (EU) N:o 2016/425 ja unionin yhdenmukaistamislainsäädännön mukainen:

RfU PPE-R/11.114 V1:2018

Tested also according to

EN 795:2012 type A

CEN TS 16415:2013 type A

(max 2 users at time)

Tested as support for suitable

winches according to

EN1496:2017 class B

Ilmoitettu laitos

n° 0123 - TÜV SÜD Product Service GmbH - Ridlerstraße 65, 80339 Munich, Germany

suoritti EU-tyyppitarkastuksen (moduuli B) ja antoi EU-tyyppitarkastustodistuksen:

P5A 023385 0237 Rev. 00

Henkilönsuojaimen sovelletaan tuotantoprosessin laadunvarmistukseen perustuvaa tyyppimukaisuutta (moduuli D) ilmoitetun laitoksen Italcert (Viale Sarca 336, 20126 Milano (MI), Italy) numero 0426 valvonnassa.

Monte Marenzo, 19/10/2020

KONG S.p.A.
Presidentti

Dr. Marco Bonaiti

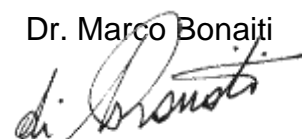

Gàidhlig

Dearbhú Comhréireachta de chuid AE

Eisítear an Dearbhú Comhréireachta seo faoi fhreagracht eisiach an monaróra:

KONG S.p.A. – Via XXV Aprile, 4 – 23804 Monte Marenzo LC – Italia

Comhlíonann an Trealamh Cosanta Pearsanta (TCP)

817.600 BIGRIG

faoi réir an dearbhaithe Rialachán (AE) 2016/425 agus caighdeáin chomhchuibhithe an Aontais Eorpaigh:

RfU PPE-R/11.114 V1:2018

Tested also according to

EN 795:2012 type A

CEN TS 16415:2013 type A

(max 2 users at time)

Tested as support for suitable

winches according to

EN1496:2017 class B

An comhlacht dá dtugtar fógra

n° 0123 - TÜV SÜD Product Service GmbH - Ridlerstraße 65, 80339 Munich, Germany

rinne sé an scrúdú AE don chineál (modúl B), agus d'eisigh sé deimhniú ar chineálscrúdú AE:

P5A 023385 0237 Rev. 00

Tá an TCP faoi réir an nós imeachta um measúnú comhréireacha cineálacha, bunaithe ar dhearbhú cáilíochta an phróisis táirgthe (modúl D), faoi fhaireachas an chomhlachta dá dtugtar fógra, uimh. 0426 Italcert (Viale Sarca 336, 20126 Milano (MI), Italy).

Monte Marenzo, 19/10/2020

KONG S.p.A.
An tUachtarán

Dr. Marco Bonaiti

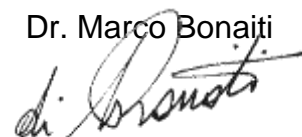

Ελληνικά

Δήλωση συμμόρφωσης ΕΕ

Η παρούσα δήλωση συμμόρφωσης εκδίδεται με την αποκλειστική ευθύνη του κατασκευαστή:

KONG S.p.A. – Via XXV Aprile, 4 – 23804 Monte Marenzo LC – Italia

Η συσκευή ατομικής προστασίας (ΜΑΠ)

817.600 BIGRIG

αντικείμενο της δήλωσης συμμορφώνεται με τον κανονισμό (ΕΕ) 2016/425 και τα πρότυπα
εναρμόνισης της Ευρωπαϊκής Ένωσης:

RfU PPE-R/11.114 V1:2018

Tested also according to

EN 795:2012 type A

CEN TS 16415:2013 type A

(max 2 users at time)

Tested as support for suitable

winches according to

EN1496:2017 class B

Ο κοινοποιημένος οργανισμός

n° 0123 - TÜV SÜD Product Service GmbH - Ridlerstraße 65, 80339 Munich, Germany

πραγματοποίησε την εξέταση τύπου ΕΕ (έγγραφο Β) και εξέδωσε το πιστοποιητικό εξέτασης ΕΕ του
τύπου:

P5A 023385 0237 Rev. 00

Το ΜΑΠ υπόκειται στη διαδικασία αξιολόγησης της συμμόρφωσης τύπου με βάση τη διασφάλιση
ποιότητας της παραγωγικής διαδικασίας (έγγραφο D) υπό την εποπτεία του κοινοποιημένου
οργανισμού αριθ. 0426 Italcert (Viale Sarca 336, 20126 Milano (MI), Italy).

Monte Marenzo, 19/10/2020

KONG S.p.A.
Ο Πρόεδρος

Dr. Marco Bonaiti

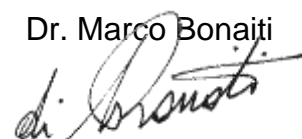

Magyar

EU Megfelelőségi nyilatkozat

Ez a Megfelelőségi nyilatkozat az alábbi gyártó kizárólagos felelőssége alatt került kibocsátásra:

KONG S.p.A. – Via XXV Aprile, 4 – 23804 Monte Marenzo LC – Italia

Az egyéni védőfelszerelés

817.600 BIGRIG

mely a nyilatkozat tárgyát képezi, megfelel az (EU) 2016/425 szabályozásának és az Európai Unió harmonizált szabványainak:

RfU PPE-R/11.114 V1:2018

Tested also according to

EN 795:2012 type A

CEN TS 16415:2013 type A

(max 2 users at time)

Tested as support for suitable

winches according to

EN1496:2017 class B

A bejelentett szervezet

n° 0123 - TÜV SÜD Product Service GmbH - Ridlerstraße 65, 80339 Munich, Germany

elvégezte az EU-típusvizsgálatot ("B" modul), és kiadta az EU-típusvizsgálati tanúsítványt:

P5A 023385 0237 Rev. 00

Az egyéni védőfelszerelés a gyártási folyamat minőség biztosításán alapuló megfelelőségértékelés tárgya (D modul), melynek felügyeletét az Italcert (Viale Sarca 336, 20126 Milano (MI), Italy). 0426 sz. hitelesítést végző szervezet végzi.

Monte Marenzo, 19/10/2020

KONG S.p.A.

Elnök

Dr. Marco Bonaiti



Latviešu

ES atbilstības deklarācija

Šī atbilstības deklarācija ir izdota vienīgi uz ražotāja atbildību:

KONG S.p.A. – Via XXV Aprile, 4 – 23804 Monte Marenzo LC – Italia

Individuālais aizsardzības līdzeklis (IAL)

817.600 BIGRIG

deklarācijas priekšmets atbilst Regulai (ES) 2016/425 un Eiropas Savienības saskaņošanas tiesību aktiem:

RfU PPE-R/11.114 V1:2018

Tested also according to

EN 795:2012 type A

CEN TS 16415:2013 type A

(max 2 users at time)

Tested as support for suitable

winches according to

EN1496:2017 class B

Paziņotā struktūra

n° 0123 - TÜV SÜD Product Service GmbH - Ridlerstraße 65, 80339 Munich, Germany

veica ES tipa pārbaudi (B modulis) un izdeva ES tipa pārbaudes sertifikātu:

P5A 023385 0237 Rev. 00

Uz IAL attiecas atbilstības novērtēšanas procedūra "Atbilstība tipam, pamatojoties uz kvalitātes nodrošināšanu ražošanas procesā" (D modulis) paziņotās struktūras Italcert (Viale Sarca 336, 20126 Milano (MI), Italy), Nr. 0426 uzraudzībā.

Monte Marenzo, 19/10/2020

KONG S.p.A.
Priekšsēdētājs

Dr. Marco Bonaiti

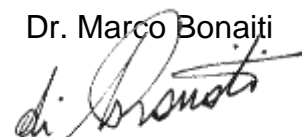

Lietuvių

ES atitikties deklaracija

Ši atitikties deklaracija išduota tik gamintojo išimtinė atsakomybe:

KONG S.p.A. – Via XXV Aprile, 4 – 23804 Monte Marenzo LC – Italia

Asmeninės Apsaugos Priemonė (IAL)

817.600 BIGRIG

deklaracijos objektas atitinka (ES) Reglamentą 2016/425 ir Europos Sąjungos derinimo teisės aktus:

RfU PPE-R/11.114 V1:2018

Tested also according to

EN 795:2012 type A

CEN TS 16415:2013 type A

(max 2 users at time)

Tested as support for suitable

winches according to

EN1496:2017 class B

Notifikuotoji įstaiga

n° 0123 - TÜV SÜD Product Service GmbH - Ridlerstraße 65, 80339 Munich, Germany

atliko ES tyrimą tipo (B modulis) ir išdavė ES tyrimo sertifikatą tipo:

P5A 023385 0237 Rev. 00

AAP taikoma atitikties vertinimo pagal tipą procedūra, pagrįsta gamybos proceso kokybės užtikrinimu (D modulis), prižiūrint notifikuotajai įstaigai nr. 0426 Italcert (Viale Sarca 336, 20126 Milano (MI), Italy).

Monte Marenzo, 19/10/2020

KONG S.p.A.
Prezidentas

Dr. Marco Bonaiti

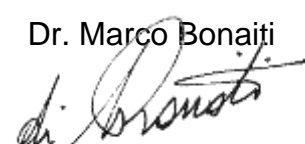

Malti

Dikjarazzjoni ta' Konformità tal-UE

Id-Dikjarazzjoni ta' Konformità tinħareġ taħt ir-responsabbiltà unika tal-manifattur:

KONG S.p.A. – Via XXV Aprile, 4 – 23804 Monte Marenzo LC – Italia

It-Tagħmir ta' Protezzjoni Personali (TPP-PPE)

817.600 BIGRIG

I-għan tad-dikjarazzjoni huwa f'konformità ma' Regolament (UE) 2016/425 u tal-istandards t'armonizzazzjoni tal-Unjoni Ewropea:

RfU PPE-R/11.114 V1:2018

Tested also according to

EN 795:2012 type A

CEN TS 16415:2013 type A

(max 2 users at time)

Tested as support for suitable

winches according to

EN1496:2017 class B

Il-korp notifikat

n° 0123 - TÜV SÜD Product Service GmbH - Ridlerstraße 65, 80339 Munich, Germany

wettaq l-eżami tal-UE tat-tip (modulu B) u ħareġ iċ-ċertifikat tal-eżami tal-UE tat-tip:

P5A 023385 0237 Rev. 00

It-TPI huwa suġġett għall-proċedura ta' valutazzjoni għat-tip abbażi tal-garanzija ta' kwalità tal-proċess ta' produzzjoni (modulu D) taħt is-sorveljanza tal-korp notifikat nru. 0426 Italcert (Viale Sarca 336, 20126 Milano (MI), Italy).

Monte Marenzo, 19/10/2020

KONG S.p.A.
Iċ-Ċermin

Dr. Marco Bonaiti

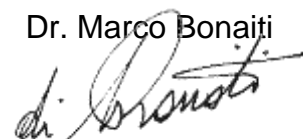

Polskie

Deklaracji zgodności WE

Niniejsza Deklaracja Zgodności została wydana na wyłączną odpowiedzialność producenta:

KONG S.p.A. – Via XXV Aprile, 4 – 23804 Monte Marenzo LC – Italia

Środek Ochrony Indywidualnej (ŚOI)

817.600 BIGRIG

przedmiot deklaracji jest zgodny z Rozporządzeniem (WE) 2016/425 i z normami zharmonizowanymi Unii Europejskiej:

RfU PPE-R/11.114 V1:2018

Tested also according to

EN 795:2012 type A

CEN TS 16415:2013 type A

(max 2 users at time)

Tested as support for suitable

winches according to

EN1496:2017 class B

Notyfikowany organ

n° 0123 - TÜV SÜD Product Service GmbH - Ridlerstraße 65, 80339 Munich, Germany

wykonał badanie typu WE (moduł B) i wydał świadectwo badania typu WE:

P5A 023385 0237 Rev. 00

ŚOI jest przedmiotem procedury oceny zgodności z typem, opierającej się na zapewnieniu jakości procesu produkcyjnego (moduł D) pod nadzorem notyfikowanego organu nr 0426 Italcert (Viale Sarca 336, 20126 Milano (MI), Italy).

Monte Marenzo, 19/10/2020

KONG S.p.A.

Prezes

Dr. Marco Bonaiti

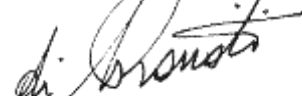

Português

Declaração de conformidade UE

A presente Declaração de Conformidade é emitida sob a exclusiva responsabilidade do fabricante:

KONG S.p.A. – Via XXV Aprile, 4 – 23804 Monte Marenzo LC – Italia

O Equipamento de Proteção Individual (EPI)

817.600 BIGRIG

objeto da declaração está em conformidade com o Regulamento (UE) 2016/425 e com as normas de harmonização da União Europeia:

RfU PPE-R/11.114 V1:2018

Tested also according to

EN 795:2012 type A

CEN TS 16415:2013 type A

(max 2 users at time)

Tested as support for suitable

winches according to

EN1496:2017 class B

O organismo notificado

n° 0123 - TÜV SÜD Product Service GmbH - Ridlerstraße 65, 80339 Munich, Germany

efetuou o exame UE de tipo (Módulo B) e emitiu o certificado de exame UE de tipo:

P5A 023385 0237 Rev. 00

O EPI está sujeito ao procedimento de avaliação de conformidade com o tipo baseado na garantia da qualidade do processo de produção (módulo D) sob vigilância do organismo notificado n. 0426 Italcert (Viale Sarca 336, 20126 Milano (MI), Italy).

Monte Marenzo, 19/10/2020

KONG S.p.A.
O Presidente

Dr. Marco Bonaiti

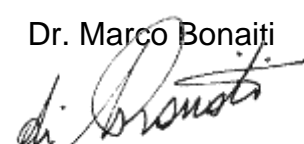

Română

Declarație de conformitate UE

Prezenta declarație de conformitate este eliberată pe răspunderea exclusivă a producătorului:

KONG S.p.A. – Via XXV Aprile, 4 – 23804 Monte Marenzo LC – Italia

Echipamentul individual de protecție (EIP)

817.600 BIGRIG

obiectul declarației, este conform cu Regulamentul (UE) 2016/425 și legislația armonizată a Uniunii Europene:

RfU PPE-R/11.114 V1:2018

Tested also according to

EN 795:2012 type A

CEN TS 16415:2013 type A

(max 2 users at time)

Tested as support for suitable

winches according to

EN1496:2017 class B

Organismul notificat

n° 0123 - TÜV SÜD Product Service GmbH - Ridlerstraße 65, 80339 Munich, Germany

a efectuat examinarea UE de tip (modulul B) și a eliberat certificatul de examinare UE de tip:

P5A 023385 0237 Rev. 00

EIP face obiectul procedurii de evaluare a conformității de tip bazată pe asigurarea calității procesului de producție (modulul D) sub supravegherea organismului notificat nr. 0426 Italcert (Viale Sarca 336, 20126 Milano (MI), Italy).

Monte Marenzo, 19/10/2020

KONG S.p.A.
Președinte

Dr. Marco Bonaiti

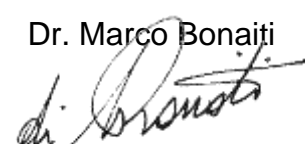



Slovenský

EÚ vyhlásenie o zhode

Toto vyhlásenie o zhode sa vystavuje na výhradnú zodpovednosť výrobcu:

KONG S.p.A. – Via XXV Aprile, 4 – 23804 Monte Marenzo LC – Italia

Osobný ochranný pracovný prostriedok (OOPP)

817.600 BIGRIG

ktorý je predmetom vyhlásenia, je v súlade s Nariadením Európskeho parlamentu a Rady (EÚ) 2016/425 a harmonizovanými normami Európskej únie:

RfU PPE-R/11.114 V1:2018

Tested also according to

EN 795:2012 type A

CEN TS 16415:2013 type A

(max 2 users at time)

Tested as support for suitable

winches according to

EN1496:2017 class B

Notifikovaný subjekt

n° 0123 - TÜV SÜD Product Service GmbH - Ridlerstraße 65, 80339 Munich, Germany

vykonal typové skúšky EÚ (formulár B) a vystavil osvedčenie o typovej skúške EÚ:

P5A 023385 0237 Rev. 00

OOPP je predmetom postupu posudzovania typovej zhody, založenej na záruke kvality výrobného postupu (formulár D) pod dohľadom notifikovaného subjektu č. 0426 Italcert (Viale Sarca 336, 20126 Milano (MI), Italy).

Monte Marenzo, 19/10/2020

KONG S.p.A.
Prezident

Dr. Marco Bonaiti

Slovenščina

EU - Izjava o skladnosti

Za izdano Izjavo o skladnosti je odgovoren izključno proizvajalec:

KONG S.p.A. – Via XXV Aprile, 4 – 23804 Monte Marenzo LC – Italia

Osebna zaščitna oprema (OZO)

817.600 BIGRIG

ki je predmet izjave, je skladna z Uredbo (EU) 2016/425 in s harmoniziranimi standardi Evropske unije:

RfU PPE-R/11.114 V1:2018

Tested also according to

EN 795:2012 type A

CEN TS 16415:2013 type A

(max 2 users at time)

Tested as support for suitable

winches according to

EN1496:2017 class B

Priglašeni organ

n° 0123 - TÜV SÜD Product Service GmbH - Ridlerstraße 65, 80339 Munich, Germany

je opravil preizkus tipa EU (obrazec B) in je izdal naslednji certifikat testiranja:

P5A 023385 0237 Rev. 00

OZO je predmet postopka ocene skladnosti na podlagi garancije kakovosti proizvodnega postopka (obrazec D) pod nadzorom priglašene organa št. 0426 Italcert (Viale Sarca 336, 20126 Milano (MI), Italy).

Monte Marenzo, 19/10/2020

KONG S.p.A.
Direktor

Dr. Marco Bonaiti

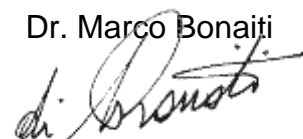

Svenska

EU-försäkran om överensstämmelse

Denna försäkran om överensstämmelse utfärdas på tillverkarens eget ansvar:

KONG S.p.A. – Via XXV Aprile, 4 – 23804 Monte Marenzo LC – Italia

Den personliga skyddsutrustningen (PPE)

817.600 BIGRIG

föremålet för försäkran, överensstämmer med förordning (EU) 2016/425 och EU:s harmoniseringsstandarder:

RfU PPE-R/11.114 V1:2018

Tested also according to

EN 795:2012 type A

CEN TS 16415:2013 type A

(max 2 users at time)

Tested as support for suitable

winches according to

EN1496:2017 class B

Det anmälda organet

n° 0123 - TÜV SÜD Product Service GmbH - Ridlerstraße 65, 80339 Munich, Germany

har utfört EU-typkontrollen (modul B) och har utfärdat intyget om EU-typkontroll:

P5A 023385 0237 Rev. 00

PPE är föremål för förfarandet för bedömning av överensstämmelse med typ baserat på kvalitetssäkringen av produktionsprocessen (modul D) under övervakning av det anmälda organet nr. 0426 Italcert (Viale Sarca 336, 20126 Milano (MI), Italy).

Monte Marenzo, 19/10/2020

KONG S.p.A.
Verkställande direktör

Dr. Marco Bonaiti

