

1 For your safety

1.1 General safety statements

- Before using this product, carefully read the Instructions for Use.
- Strictly follow the Instructions for Use. The user must fully understand and strictly observe the instructions. Use the product only for the purposes specified in the Intended Use section of this document.
- Do not dispose of the Instructions for Use. Ensure that they are retained and appropriately used by the product user.
- Only fully trained and competent users are permitted to use this product.
- Comply with all local and national rules and regulations associated with this product.
- Only trained and competent personnel are permitted to inspect, repair and service the product. Dräger recommends a Dräger service contract for all maintenance activities and that all repairs are carried out by Dräger.
- Properly trained service personnel must inspect and service this product as detailed in the Maintenance section of this document.
- Use only genuine Dräger spare parts and accessories, or the proper functioning of the product may be impaired.
- Do not use a faulty or incomplete product, and do not modify the product.
- Notify Dräger in the event of any component fault or failure.
- The air supply shall meet the requirements for breathing air according to EN12021.

1.2 Definitions of alert icons

Alert icons are used in this document to provide and highlight text that requires a greater awareness by the user. A definition of the meaning of each icon is as follows:

 **WARNING**
Indicates a potentially hazardous situation which, if not avoided, could result in death or serious injury.

 **CAUTION**
Indicates a potentially hazardous situation which, if not avoided, could result in physical injury or damage to the product or environment. It may also be used to alert against unsafe practices.

 **NOTICE**
Indicates additional information on how to use the product.

2 Description

2.1 Product overview

The Dräger PSS® 3000 Series is a self contained breathing apparatus (SCBA) that uses an open-circuit breathing system. The series is compatible with a wide range of compressed-air cylinders, face masks and lung demand valves (e.g. FPS 7000 and Panorama Nova face masks, PSS Series lung demand valves, and steel or composite cylinders).

2.2 Feature description

The carrying system uses a lightweight polymer-composite space frame (Fig 1, Item 3). The shoulder straps and waist belt are fully adjustable and use webbing harness straps and moulded padding on the shoulder pads and waist pad.

The apparatus uses the Dräger high-performance pressure reducer (6) that reduces cylinder pressure and supplies breathing air through a medium-pressure hose (5) and coupling (1) to the attached lung demand valve. The apparatus is fitted with a mechanical pressure gauge (4) that incorporates a whistle that sounds to warn the wearer that there is low cylinder pressure. A dual-pressure hose (7) supplies air to the whistle when it is activated, and has an internal capillary tube that supplies high-pressure air from the cylinder to the gauge.

The air hoses and the pressure reducer are integrated into the space frame to prevent snagging and enhance component protection. The hose clips (2) hold the air hoses in position on the shoulder straps.

Air cylinders, lung demand valves and face masks

The Dräger PSS 3000 Series is compatible with a single steel or composite material cylinder of 4 to 9 litre capacity, and 200 or 300 bar pressure. Full descriptions and user instructions are contained in separate instructions supplied with the cylinder, mask or lung demand valve.

2.3 Intended use

The PSS 3000 Series breathing apparatus, when fitted with a cylinder, lung demand valve and face mask, is intended for use by emergency services and in industrial applications where a high level of respiratory protection is required. The assembled breathing apparatus provides the wearer with respiratory protection for working in contaminated or oxygen-deficient conditions, and is suitable for fire fighting.

The cylinder, lung demand valve, face mask and other accessories used with this product must be certified Dräger components, assembled in an approved configuration. Contact Dräger for further information.

Use in potentially explosive atmospheres

Electronic sub-assemblies are ATEX certified.

2.4 Approvals

The European standards, guidelines, and directives according to which this product is approved are specified in the declaration of conformity (see declaration of conformity or www.draeger.com/product-certificates).

2.5 Explanation of marking and symbols

Refer to the relevant authority for explanation of approval body symbols and marking on the equipment. Examples of other marking on component parts of the breathing apparatus are:

BRAC-1359	–	Dräger serial number
08/09	–	Month and year of manufacture
3356812 or R21034	–	Dräger part number
SF	–	Standard force coupling
LF	–	Low force coupling

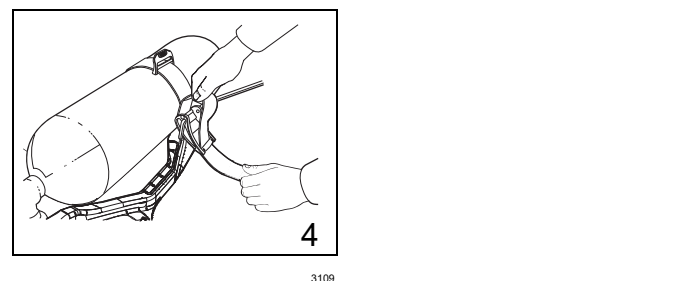
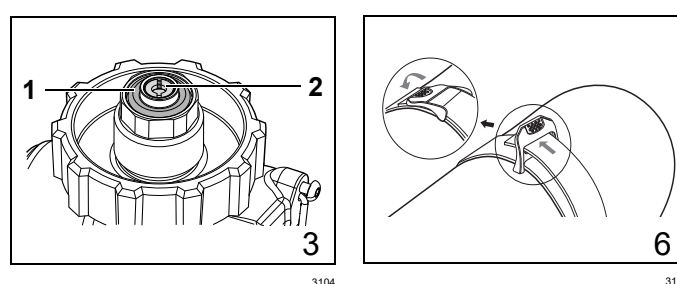
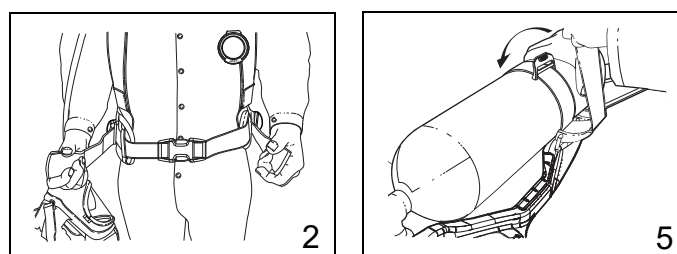
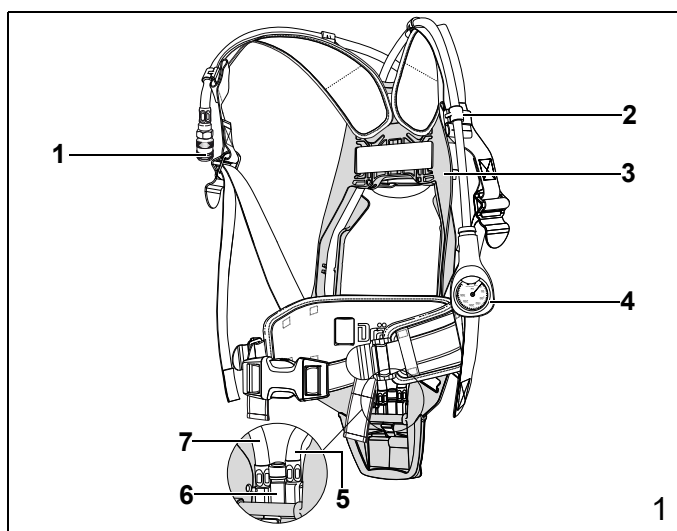

3 Use

 **WARNING**
Only trained and competent personnel may prepare and use breathing apparatus. Ensure that any accessories, ancillary equipment and other protective clothing items do not interfere with the apparatus and do not create a safety hazard.

The effective working duration of the apparatus is dependent on the initial air supply available and the breathing rate of the wearer. Fill air cylinders to their full rated pressure prior to use, and do not commence any operation using a cylinder that is less than 90 per cent full (or greater when national regulations dictate).

 **CAUTION**
Do not apply excessive force or use tools to open or close a cylinder valve, and do not drop or throw down the breathing apparatus.

3.1 Preparation for use

 **NOTICE**
The face of the pressure gauge may be fitted with a thin flexible protective covering. Remove this covering before first use.

1. Carry out a visual inspection of the breathing apparatus (see Section 3.5.1).
2. Fit the air cylinder (see Section 3.5.2).
3. For breathing apparatus with a medium-pressure coupling for the lung demand valve, disconnect and then reconnect the male coupling. To connect, press the male coupling into the female coupling until an audible click is heard. If there is any difficulty disconnecting or connecting, see the troubleshooting information in Section 4.
4. Press the reset button when using a positive-pressure lung demand valve (see the Instructions for Use supplied with the lung demand valve).
5. Carry out a full functional test of the apparatus (see Section 3.5.3).
6. Connect the lung demand valve to the face mask and check the security of attachment by gently attempting to pull the coupling apart.

3.2 Putting on the breathing apparatus

1. Fully loosen the shoulder straps and waist belt and put on the breathing apparatus.
2. Check that the shoulder pads are not twisted and take the weight of the system on the shoulders by pulling the shoulder straps. Do not fully tighten at this stage.
3. Close the waist belt buckle and pull the ends of the waist belt forward until the strap padding fits securely and comfortably over the hips (Fig 2). Tuck the belt ends behind the waist pad or belt.
4. Pull the shoulder straps until the breathing apparatus rests securely and comfortably on the hips. Do not over tighten. Tuck the belt ends behind the waist pad or belt.
5. Fully loosen the head straps of the face mask and place the neck strap over the back of the neck.
6. Press the reset button when using a positive-pressure lung demand valve.
7. Open the cylinder valve slowly, but fully, to pressurize the system.

8. Put on the face mask and check for tight fit (see the Instructions for Use supplied with the mask).

3.3 During use

 **WARNING**
Fully open the cylinder valve and ensure that it remains open during use.

Users should be in a safe area before the whistle warning commences. Evacuate to a safe area immediately if the warning commences during an operation.

Using the supplementary air supply will use air from the cylinder and rapidly reduce the working duration of the apparatus.

- Regularly check the remaining cylinder pressure on the gauge.
- If supplementary air is required, briefly press the rubber cover at the front of the lung demand valve to deliver extra air into the face mask.

3.4 After use

 **WARNING**
Do not remove the breathing apparatus until in a safe breathing environment.

1. Loosen the face mask straps. As the seal to the face is broken, press the reset button when using a positive-pressure lung demand valve. Remove the face mask.
2. Close the cylinder valve.
3. Press the rubber cover at the front of the lung demand valve to vent the system fully. Press the reset button when using a positive-pressure lung demand valve.
4. Release the waist belt buckle.
5. Lift the shoulder strap buckles to loosen the straps.
6. Remove the breathing apparatus and face mask.
7. Carry out the after use tasks in the maintenance table (see Section 5).
8. Remove the air cylinder (see Section 3.5.2) if required.
9. Pass the breathing apparatus to the service department with details of any faults or damage that occurred during use.

3.5 Common user tasks

3.5.1 Visual inspection

A visual inspection must check the full breathing apparatus including all component parts and accessories. Check that the equipment is clean and undamaged, paying particular attention to pneumatic components, hoses and connectors. Typical signs of damage that may affect the operation of the breathing apparatus include impact, abrasion, cutting, corrosion and discolouration. Report damage to service personnel and do not use the apparatus until faults are rectified.

3.5.2 Air cylinder fitting and removing

 **WARNING**
High-pressure air release may cause injury to the user or other personnel near the breathing apparatus. Close the cylinder valve and fully vent the system before attempting to disconnect an air cylinder.

Impact damage to the cylinder valve or reducer connector may prevent valve connection or cause an air leak. Handle the air cylinder and breathing apparatus with care.

 **NOTICE**
For other cylinder connector types, refer to the Instructions for Use supplied for the connector.

Fitting a cylinder with a threaded connector

1. Check the threads of the cylinder valve port and the pressure reducer. Ensure that the O-ring seal (Fig 3, Item 1) and the sintered filter (2) in the reducer are clean and undamaged.
2. Lay the apparatus horizontal, with the reducer uppermost, and fully extend the cylinder strap.
3. Insert the cylinder through the loop of the strap, and align the valve with the reducer.
4. Lift the cylinder and space frame into the vertical position (supported on the end of the cylinder opposite the valve).
5. Tighten the hand wheel of the reducer, using only the thumb and index finger, until a definite metal-to-metal contact is felt. **Do not** use tools or over tighten.
6. Place the unit back into the horizontal position.
7. Take up the slack in the cylinder strap (Fig 4).
8. Pull the strap over the cylinder to operate the cam lock (Fig 5).
9. Secure the strap end using the cylinder strap retainer (Fig 6). Release the cam lock to adjust the position of the cylinder strap retainer if necessary.

Removing a cylinder with a threaded connector

1. Close the cylinder valve and fully vent the system.
2. Lay the apparatus horizontal, with the cylinder uppermost.
3. Lift the cylinder strap retainer.
4. Lift the strap against the cam lock to release the buckle tension, and then loosen the strap.
5. Disconnect the cylinder valve from the pressure reducer.
6. Lift the cylinder away from the reducer and remove the cylinder.

3.5.3 Functional testing

 **WARNING**
Failure of the breathing apparatus to meet any of the standards or parameters described in the functional tests indicates a system fault. Report the fault to trained service personnel or contact Dräger. Do not use the breathing apparatus until the fault condition is rectified.

Assemble the breathing apparatus as described in the preparation for use (see Section 3.1) before commencing any functional testing.

Leak test and whistle warning test

1. Press the reset button when using a positive-pressure lung demand valve.
2. Slowly and fully open the cylinder valve (anticlockwise). During pressurization a momentary sounding of the whistle will occur.
3. Fully close the cylinder valve.
4. After one minute, check the contents gauge and then reopen the cylinder valve. The gauge must not show an increase in pressure of more than 10 bar (one radial marking on the gauge face). Investigate and repair a failed leak test (see Section 4), and then repeat the leak test.
5. Fully close the cylinder valve.

6. Observe the contents gauge and slowly release the pressure as follows:
 - a. Positive-pressure lung demand valves – Cover the outlet port of the valve with the palm of the hand. Press the rubber cover to switch on the positive pressure. Vent the system by carefully lifting the palm of the hand from the outlet port to maintain a slow pressure decrease.
 - b. Negative-pressure lung demand valves – Slowly vent the system by carefully pressing the rubber cover.
7. The whistle must begin to sound in the range 60 bar to 50 bar.
8. Continue to vent the system until fully exhausted.
9. Press the reset button when using a positive-pressure lung demand valve.

4 Troubleshooting

The troubleshooting guide shows fault diagnosis and repair information applicable to breathing apparatus users. Further troubleshooting and repair information is available in Instructions for Use supplied with associated equipment.

Where the troubleshooting guide shows more than one fault or remedy, carry out repair actions in the order that they appear in the table.

Contact service personnel or Dräger when the remedy information indicates a service task, or if the symptom remains after all remedy actions have been attempted.

Symptom	Fault	Remedy
High-pressure air leak or failed leak test	Loose or dirty connector	Disconnect, clean and reconnect couplings and retest
	Faulty hose or component	Substitute user replaceable accessories and retest
Air leak from medium- pressure hose connection at the pressure reducer (safety relief valve)	Faulty O-ring, retainer, spring or pressure reducer	Service task
High or low medium pressure	Pressure reducer fault	Service task
Poor sounding whistle	Whistle dirty	Clean whistle flute and retest
Whistle not functioning correctly	Activation mechanism fault	Service task
Difficulty connecting or disconnecting the medium-pressure quick coupling	Dirty connector	Disconnect, clean and reconnect couplings and retest
	Burring of the male coupling	Replace the hose with the male coupling

5 Maintenance

5.1 Maintenance table

Service and test the breathing apparatus, including out-of-use apparatus, in accordance with the maintenance table. Record all service details and testing. Refer also to the Instructions for Use for the lung demand valve, face mask and other associated equipment.

Additional inspection and testing may be required in the country of use to ensure compliance with national regulations.

Component/ System	Task	Before use	After use	Every month	Every year	Every 6 years	Every 10 years	
Complete apparatus	Visual inspection (see Note 1 and Section 3.5.1)	○	○	○				
	Functional testing (see Section 3.5.3)	○	○	○				
	Breathing cycle and static tests (see Note 2)				○			
Lung demand valve	Check push-in type connectors for lubricant (see Note 3)	○						
	Check the male element of the quick coupling for burring (see Step 3 in Section 3.1)				○			
	Overhaul. Contact Dräger for the Repair Exchange (REX) service (see Note 4)					○		
Pressure reducer	Medium-pressure check (see Note 2)				○			
	Inspect the sintered filter (see Note 2 and Note 5)				○			
	Inspect the high-pressure connector O-ring (see Note 2 and Note 6)				○			
	Overhaul. Contact Dräger for the Repair Exchange (REX) service (see Note 7)					○	○	
Cylinder	Charge cylinder to correct working pressure	○	○					
	Check charged pressure (stored cylinders only)			○				
	Check test date of cylinder			○				
	Recertification	According to national regulations in the country of use						
Cylinder valve	Overhaul	At the time of cylinder recertification						

Notes

○ Dräger recommendations

- 1 Clean the equipment if it is dirty. If the equipment has been exposed to contaminants, disinfect any components that come into direct and prolonged contact with the skin.
- 2 These maintenance tasks may only be carried out by Dräger or trained service personnel. Details of the tests are contained in the Technical Manual which is issued to service personnel that have attended a relevant Dräger maintenance course.
- 3 For type A check the O-ring on the lung demand valve; and for type ESA check the outer surface of the male part of the push-in connector on the lung demand valve. As a guide, lubricant should be felt on the fingers but not seen. If relubrication is required, lightly apply Dow Corning® Molykote® 111 (other lubricants are not tested and may damage the equipment).
- 4 Overhaul every 6 years is applied to equipment users subject to German regulations only. Users in Germany must meet the requirements of: German fire brigade regulations (FwDV 7 and vfdB – RL0804), and German national regulations (BGR 190 or GUV R190 and GUV-I-8674).
- 5 Replace the sintered filter if a drop in reducer performance is observed during a flow check or if it is visibly damaged.
- 6 Replace the high-pressure connector O-ring if it is found to leak during functional testing or if the O-ring is visibly damaged.
- 7 Where the breathing apparatus is subjected to a high level of use (in training establishments etc.), reduce the overhaul period for the pressure reducer. In these circumstances, Dräger recommend that the overhaul frequency should be less than 5,000 applications of use. An application of use is defined as a single use of the fully assembled breathing apparatus, where the user breathes from the air cylinder. It does not include system pressurization for pre-operational checks

5.2 Cleaning and disinfecting



CAUTION

Do not exceed 60 °C for drying, and remove components from the drying facility immediately when dry. Drying time in a heated dryer must not exceed 30 minutes.

Do not immerse pneumatic or electronic components in cleaning solutions or water.

If water is trapped and then freezes inside the pneumatic system of the breathing apparatus (such as the lung demand valve), operation will be impaired. Prevent any liquid from entering, and thoroughly dry the breathing apparatus after cleaning to prevent this from occurring.



For information about suitable cleaning and disinfecting agents and their specifications refer to document 9100081 on www.draeger.com/IFU.

Refer also to the Instructions for Use for the lung demand valve, face mask and other associated equipment.

- Use only clean lint-free cloths

1. Clean the breathing apparatus manually using a cloth moistened with cleaning solution to remove excess dirt.
2. Apply disinfecting solution to all internal and external surfaces.
3. Rinse all components thoroughly with clean water to remove all cleaning and disinfecting agents.
4. Dry all components using a dry cloth, in a heated dryer or in air.
5. Contact service personnel or Dräger if disassembly of the harness, space frame or pneumatic components is required.

5.3 Maintenance work

5.3.1 Air cylinder charging



WARNING

The air supply shall meet the requirements for breathable air according to EN12021.

Refer to the instructions supplied with the cylinder and the charging apparatus for recharging a compressed air cylinder.

6 Storage

6.1 Storage preparation

- Extend the shoulder straps, waist belt and the straps of the face mask.
- For storage, place the face mask in a protective bag (contact Dräger for supply of a suitable bag).
- Route rubber hoses in such a way that the bend radius is not too acute and the hose is not stretched, compressed or twisted.

6.2 Storage conditions

- Store the equipment between -15 °C and +25 °C. Ensure that the environment is dry, free from dust and dirt, and does not subject the equipment to wear or damage due to abrasion. Do not store the equipment in direct sunlight.
- Fix the breathing apparatus securely to any raised mounting point to prevent it from falling.

7 Technical data

High-pressure connection	Standard G5/8" as per EN 144-2 (200 bar or 300 bar)
Compressed air cylinders	4 litre to 9 litre (200 bar or 300 bar), steel or composite materials
Whistle warning	Initial activation: 60 bar to 50 bar
Medium pressure	6 bar to 9 bar
Operating temperature	EN137 temperature range

8 Order list

Description	Quantity	Order code
Dow Corning® Molykote® 111	100 grams	3331247