

1115 OVAL COMPACT LOCK

A compact aluminum alloy carabiner with an exceptional strength to weight ratio. Keylock closure prevents snagging during use. Screw gate locking system.

TOWERS/INDUSTRY





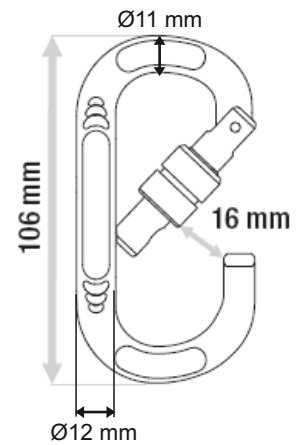

CONSTRUCTION

ROOFS

SELF RESCUE

TECHNICAL SHEET



Ref.	Product name Nombre del producto	Weight Peso								CE	EN 12275	EN 362
		g	oz									
1115	OVAL COMPACT LOCK	71	2.5	24	10	7	15	106	57	X	B	