

# BUCKINGHAM MFG.

## Harness Instructions

**Read and understand** all labels and instructions attached to and packed with your harness. For the following instructions, refer to accompanying figures, “A” through “I”.

NOTE: These instructions are applicable to all designs referenced in those figures below as they relate to your harness. Also reference requirements and information provided in Annex A.

**FIGURE “A” (H Style)**

### Straightening Your Harness:

(FIGURE “A”) Pick up your harness by the fall arrest attachment (item ‘D’) and shake it to allow the straps to fall free of each other. Make sure the leg strap buckles are unbuckled at this time. At this point, you may note the different colors of the webbing. Typically, the leg straps and the shoulder straps will be a contrasting color. Kevlar harnesses will have a contrasting colored strip on the leg and sub-pelvic straps to distinguish them from the shoulder straps.

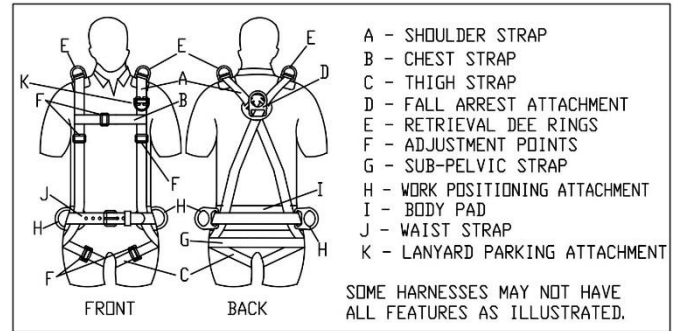

### Daily Harness Inspection:

(FIGURE “B”) Hold the harness with one shoulder strap in each hand to check for twisted straps. Straighten any twisted straps so that they hang freely. Inspect all areas of your harness for worn or frayed straps, broken stitches, faulty hardware, or any other signs of damage or excessive wear. If any of the above problems are found, destroy and discard the harness.

**FIGURE “A” (Cross-Over Style)**

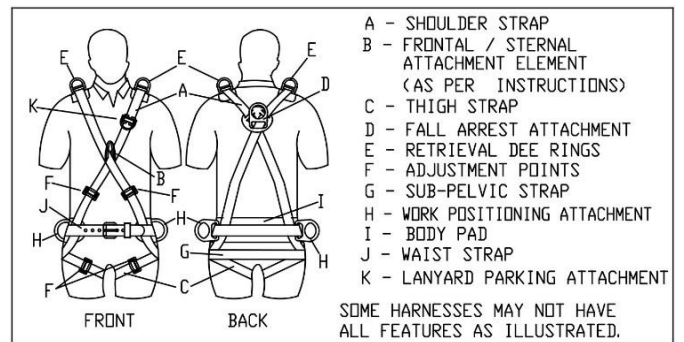

### Donning Harness (H Style):

Slide the shoulder straps over your arms, as you would a shirt, and into position on the shoulders with the fall arrest attachment in the upper, middle portion of your back (ref. FIGURE “C”). Check to be sure that the straps are not twisted. Attach the chest strap (item ‘B’ ref. FIGURE “A” H Style) loosely at this time to prevent the Harness from slipping off your shoulders.

**FIGURE “A” (Y- Style)**

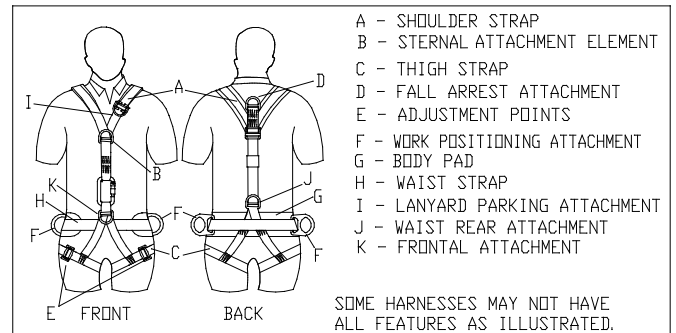

### Donning Harness (Cross-Over & Y- Styles):

Begin by holding both shoulder straps in your left hand. Slide the shoulder straps over the left shoulder. Put the Right shoulder strap over the head. When properly positioned, the head will be between the shoulder straps within an area bounded by the fall arrest attachment on the back and the sternal attachment element on the front. The fall arrest attachment should be positioned in the upper, middle portion of your back and fall 2 in. above or below the underside of your armpit (ref. FIGURE “C” Cross-Over Style & FIGURE “A” Y- Style). The sternal attachment element location shall fall from the underside of your armpit to 4 in. below (ref. FIGURES “A” Cross-Over & Y- Style). The frontal attachment element location shall fall from 4 in. below the underside of your armpit to 4 in. below your navel. Check to ensure that the straps are not twisted.

NOTE: Lanyard parking attachment is not to be used as a load bearing anchor point.

**FIGURE “B”**

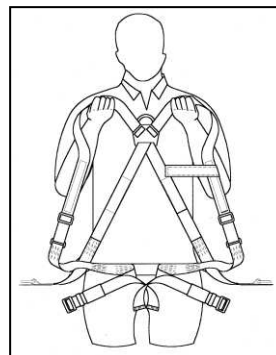

**FIGURE “C”**

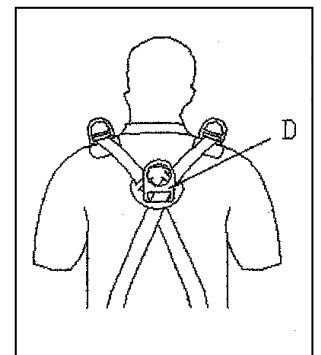

## Weaving The Quick Connect Buckle:

If your harness is equipped with Quick Connect Buckles and the tab end of the Quick Connect Buckle has been removed from the harness weave the webbing through the Quick Connect Buckle as shown in FIGURE "D" (under the slide bar and up through the front slot, then over the slide bar and down through the rear slot).

## Leg Strap Attachment: [Harness Equipped With Interlocking Buckles]

The long portion of the leg straps will be hanging down behind you. Pull this portion between the legs, adjust to length, and connect to the connecting buckle of the other end of the leg strap (see FIGURE "E" for details of interlocking buckles) Again, be sure that the leg straps are not twisted. Secure the excess strap with the elastic band. Slide the plastic keeper against the buckle after adjustment as outlined below.

## [Harness Equipped With Quick Connect Buckles]

The long portion of the leg straps will be hanging down behind you. Pull this portion between the legs, adjust to length, and connect to the connecting buckle of the other end of the leg strap (see FIGURE "F" for details of Quick Connect Buckles). Again, be sure that the leg straps are not twisted. Secure the excess strap with the elastic band.

## [Harness Equipped With Tongue Buckles]

The grommeted portion of the leg straps will be hanging down behind you. Pull this portion between the legs and through the buckle until snug around the leg (see FIGURE "G" for details). Again, be sure that the leg straps are not twisted. Secure the excess strap with the elastic band. Slide the free end of the strap through the leather keeper.

## Adjustments:

Use adjustment points ('F') on leg straps and shoulder straps (ref. FIGURES "A") to properly fit your harness. Upon completion of adjustments, ensure the fall arrest attachment is in the upper, middle portion of your back as stated in these instructions under "Donning Harness". The leg strap buckles should lie on your sides, just below the hips. If your harness has a front attachment element "B" (FIGURE "A" Cross-Over Style), it must be located as stated in these instructions under "Donning Harness". If your harness has work positioning dee rings ('H'), it should fit so there is one dee ring on each hip. Retrieval dee rings should be adjusted so as to be between the neck and the shoulders. If your harness has a chest strap "B" (FIGURE "A" H Style) it MUST be located across the upper chest area, (i.e. bottom of chest strap should be approx. located at bottom of sternum) and be properly attached and adjusted. For hook and loop attachment chest straps, see accompanying instruction sheet for additional important installation details. Shoulder straps must be properly maintained on the shoulder (ref. FIGURE "H"). All straps should be adjusted so they are snug and comfortable, but not loose.

FIGURE "D"

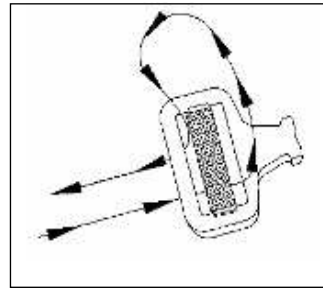

FIGURE "E"

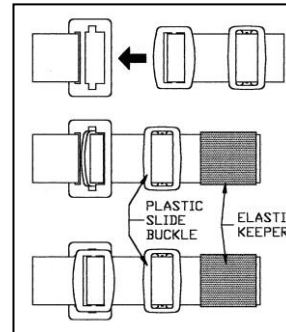

FIGURE "F"

to the connecting

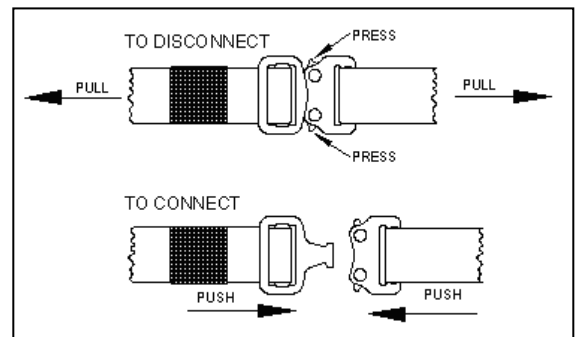

FIGURE "G"

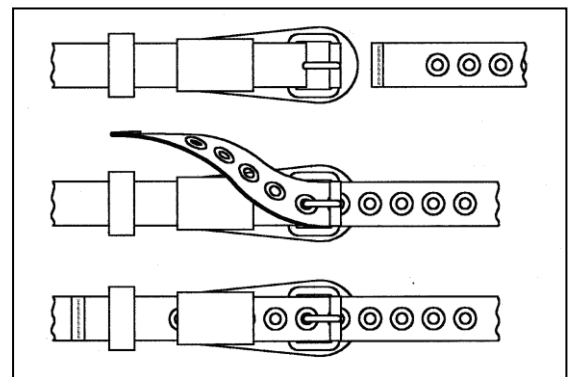
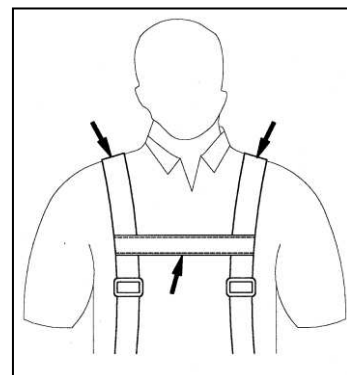

FIGURE "H"



## Body Belt Attachment (optional):

Some harnesses are equipped with outside mount straps in the waist area for attachment of a body belt (ref. FIGURE "I"). Unbuckle these straps and secure the body belt around the waist. Slide each outside mount strap between the body of the belt and the waist strap. Reconnect the buckles.

**Note:** Straps with plastic buckles are not for support or fall arrest. They are only for retaining a work positioning belt.

FIGURE "I"

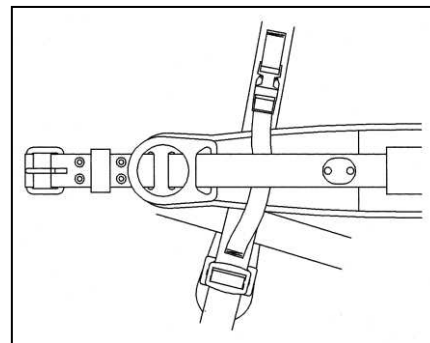

## Additional Instructions / Warnings for Quick Connect Buckle

### For your information and attention:

Quick Connect Buckles on those Full Body Harnesses (FBH) and Arborist's Tree Saddles that include this style of buckle may unintentionally disengage under the condition outlined below:

If the pawls of the buckle do not freely rotate, proper engagement of the tab end to the receptor end of the buckle will be hindered / restricted. If as a result of the users movements or through contact with an obstruction during the course of his/her work, one of the two pawls of the receptor end of the buckle is depressed while tension is induced on the strapping attached to the buckle, the potential exists that disengagement of the tab end of that side from the pawl may occur. If that position is maintained and again through the users movements or contact with an obstruction the opposite side pawl is depressed, the tab end of the buckle may totally disengage from the receptor end.

### To eliminate the potential for this condition, you the user should:

1. Inspect your equipment before each use as you would for all safety equipment. Equipment should be replaced if you have any question / doubt about it being safe for use.
2. Always position the buckles of your equipment so that contact with obstructions is avoided.
3. Test the pawls on your Quick Connect Buckles to ensure they freely rotate and return back to their original position. If any pawl does not freely rotate, the buckle should be (a) cleaned as outlined below to ensure there are no obstructions inside the buckle hindering its intended function and (b) lubricated with a lightweight lubricant such as BuckLube, WD-40®, Etc. as recommended for locking snaphooks. If the pawl still does not freely rotate, you should contact Buckingham Mfg. at the telephone number outlined below and request a Returned Goods Authorization Number for immediate return of your harness or Arborists tree saddle for our inspection and/or buckle replacement.
4. Ensure the receptor end and tab end of the Quick Connect Buckle is fully connected with both locking pawls engaged. When the two halves are properly attached together, a clicking sound should be heard. Complete by pulling the adjuster strap through the buckle and tighten until it is snug but comfortable, thus ensuring complete engagement.

Buckingham's primary concern is to provide a quality product to its customers to enable them to carry out their profession in a safe manner. However, we always require our customer's assistance in proper equipment operation, inspection and maintenance.

## INSTALLATION INSTRUCTIONS FOR HOOK AND LOOP FASTENER CHEST STRAP 63\_\_\_\_\_ SERIES HARNESSSES

### STEP 1

Slide the free end of the chest strap beneath the right shoulder strap. See figure 1.

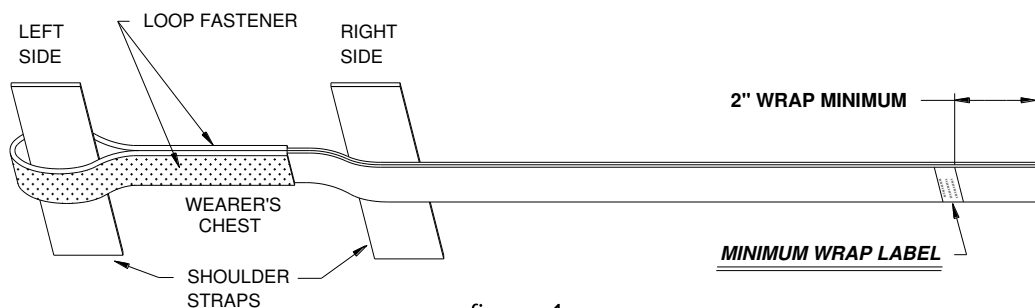

## STEP 2

Wrap the chest strap around the right shoulder strap and continue across the front of the left shoulder strap. Ensure that the hook and loop fasteners are securely attached. See figure 2.

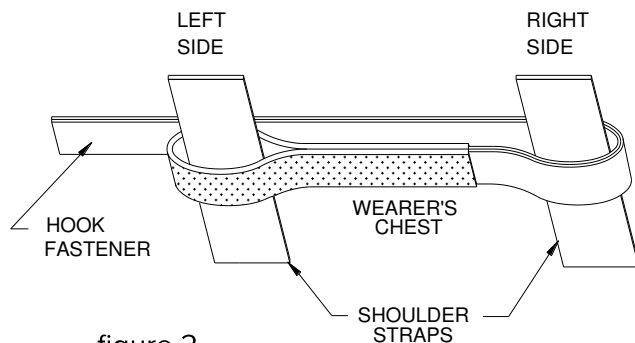

figure 2

## STEP 3

Continue to wrap until the minimum wrap label is at least 2" behind the left shoulder strap. See figure 3.

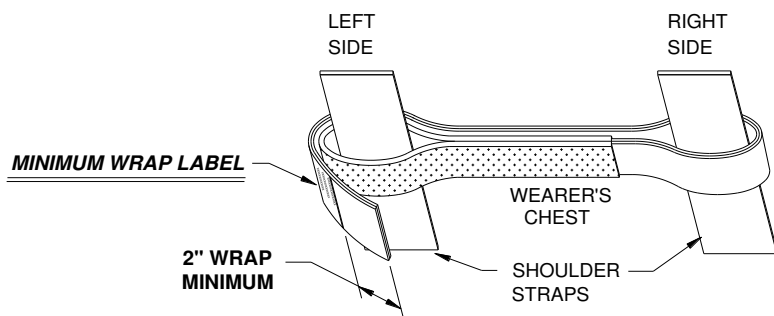

figure 3

**CAUTION** strap **MUST** be wrapped a minimum of 2 inches around the back of the shoulder strap.

## HOOK AND LOOP FASTENER CHEST STRAP CLOSURE INFORMATION

- Pressing the fastener together will increase the fastener's resistance to unintentional separation (opening). Vibration over time will produce the same effect.
- Most oils do not significantly affect closure performance
- Cold improves the rated closure strength, however, it may reduce cycle life.
- Melting temperature: 400° F

## INSTRUCTIONS / WARNING

### Full Body Harnesses (FBH)

Manufacturer's instructions shall be provided to the user of this product. If additional copy is needed, contact Buckingham Mfg. Co. Read carefully, understand and heed these and all instructions, warnings and cautions as well as the ANSI Z359 "General Requirements and Information" provided in the included Annex "A" and packaged with this product before using this equipment. Failure to do so could result in your serious injury or death. Employer – instruct employee as to the proper use, warnings and cautions before use of this equipment.

ANSI Z359.11, ASTM F887, CSA Z259.10 and applicable OSHA regulations are standards / regulations utilized by Buckingham Manufacturing Co. for various full body harnesses (FBH) manufactured. Harnesses are labeled to these standards as they are applicable.

Buckingham harnesses are intended as personal protection equipment for use by properly trained professionals only. Each piece of equipment is important in its function and design and in its relationship to all other components. Energy absorbing lanyards should be considered as a part of a personal fall arrest system used in conjunction with a harness. The energy absorber (pack end) must always be attached to the fall arrest attachment device included on the users equipment. Cover of energy absorber should not be removed and will not have any effect on the shock absorbing feature. Harnesses must be worn so the fall arrest attachment is centered in back near shoulder blade level. It is recommended that:

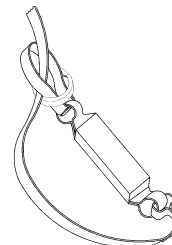

- A connecting device and fall arrest attachment manufactured with a web loop be attached with a hitch (See detail), or carabiner.
- If using a locking snap hook to a web loop fall arrest attachment the web loop must be protected by an integral wear piece to enhance visual inspection.

- All Web loop fall arrest attachments must be inspected before each use. The inspection should include, but not be limited to, inspecting for: webbing cuts, kinks, abrasions, burns, excessive swelling, excessive wear, discoloration, charring, broken fibers, loose stitching and chemical or physical exposures.

Note: The use of a locking snaphook to a web loop fall arrest attachment without an integral wear piece is acceptable in emergency situations (i.e. rescue, evacuation, etc.) Attachment of a locking snap hook to a web loop fall arrest attachment with no wear piece can cause premature wear of the webbing and stitching. This degradation can cause the web loop layers to separate and be incapable of supporting your weight. Therefore the web loop fall arrest attachment must be inspected before use. Additionally, connections used to attach to the fall arrest attachment must have a minimum gate rating of 3600 lbf. and meet ANSI Z359.12 requirements.

OSHA requires that impact force in a fall not exceed an 1800 lbf. limit with a harness. Proper use of a harness with an energy absorbing lanyard will allow compliance with these limits when properly assembled.

Selection of products should be such that they aid the worker in the performance of his job and particular work situation. See sections 10-16 of the included Annex "A" which provides additional information concerning the location and use of various attachments that may be provided on the Full Body Harness (FBH). Therefore, be certain this equipment is suitable for the intended use and work environment. It should only be used as personal protection equipment if suitability for intended use is questionable, always consult your Supervisor, Safety Director or contact Buckingham Mfg. at (607) 773-2400 or 1-800-937-2825.

No fall protection system can guarantee that you will not sustain injuries should a fall occur. Therefore, lanyards should be kept as short as possible to minimize free fall distance. OSHA specifies that maximum length of lanyard shall provide for a fall of no greater than six (6) feet. In addition other factors such as harness stretch not to exceed 18", D-ring / connector length, settling of the user's body, lanyard length, including energy absorber extension and all other contributing elements should be such that the user can not fall a distance that will allow contact with any lower level. The lanyard attachment point on the user should be in the middle of the back near shoulder blade level. Do not lengthen a lanyard by tying or knotting to another lanyard or connecting a snap to a snap. Lanyards should not be shortened by knotting rope or webbing as this can reduce the strength by 50% or more. NOTE: The hitch detailed above is not considered a knot.

Do not alter your harness or any safety product in any way. If your harness does not fit properly, replace it with one of the correct size. Wear your harness snug but not tight.

Unless the snap hook is a locking type with minimum gate rating of 3600 lbf., meets ANSI Z359.12 requirements, and designed for the following connections, snap hooks shall not be engaged:

- directly to webbing, rope or wire rope
- to each other - they are not intended to be used that way and could twist apart
- to a D-ring to which another snap hook or other connector is attached.
- to a horizontal lifeline
- to any object which is incompatibly shaped or dimensioned in relation to the snap hook such that the connected object could depress the snap hook keeper a sufficient amount to cause it to release. (See Illustration)

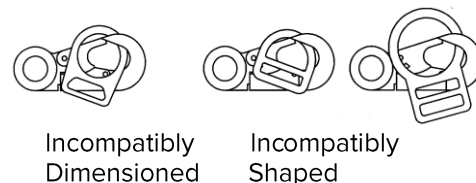

Thorough employee training in the selection and proper use of personal protection equipment is imperative.

## CAUTION

- ANSI Z359.11 and CSA Z259.10 recognize the use of this harness only within the capacity range of 130 - 310 lbs.
- Buckingham harnesses only can be used by a person with a maximum weight of 420 lbs. when fully equipped and only when used with an equivalently weight rated energy absorbing lanyard / accessories. Note: This maximum weight does not apply to body belts attached to a harness.
- Fall protection equipment, (i.e. fall arrest, work positioning belts, retrieval, suspension etc.) should not be resold or provided to others for re-use after use by original user as assurance cannot be granted that a used product meets criteria of applicable standards and is safe for use to a subsequent user.
- Only Buckingham Mfg. Co. or those people authorized in writing by Buckingham Mfg. Co. may make repairs to this equipment.
- Equipment subjected to impact loading must be immediately removed from service, destroyed and discarded.
- In the event of a fall, the employer must have a rescue plan and the means to implement it.
- Attach only locking connecting devices meeting standards / regulations for intended use for fall arrest, positioning and suspension to rear fall arrest D-ring on harness and fall arrest anchor point, saddle / belt D-rings and attachment points.
- Only positioning connecting devices should be attached to side D-rings, as side D-rings are not intended for fall arrest.
- Do not connect any tools, accessory loops / snaps, etc. to the positioning D-rings. D-rings are for attachment of connecting device locking snap hooks only.
- For units with Work Position Web Loop(s): Buckingham recommends attachment only to carabiner. Buckingham Mfg. **does not** recommend attachment of a metal connector, other than a carabiner, to a web loop fall arrest attachment unless the web loop is protected by an integral wear piece, the connector meets the requirements of ANSI Z359.12 (3600 lbf. rated gate), the snap hook lock mechanism cannot inadvertently be depressed, and the web loop fall arrest attachment point is inspected prior to each use.
- Attachment of a metal connector, such as a locking snap hook, to a web loop fall arrest attachment with no wear piece can cause premature wear of the webbing and stitching. This degradation can cause the web loop layers to separate and be incapable of supporting your weight.
- If connecting to a personal fall arrest system by attaching directly through the web loop of an energy absorber carefully inspect the inside of the web loop for cuts, abrasions, broken strands, or excessive wear.

- Buckingham harnesses are manufactured with a breakaway lanyard parking attachment that is generally located in the sternal area of the harness. This lanyard parking attachment is designed only to store unused lanyard legs to help reduce tripping and entanglement hazards. Lanyard parking attachments are designed to breakaway at no more than 120 lbf. and are not to be used as load bearing anchor points.
- Fall arrest anchor points must support a minimum of 5000 lbf. per attached worker and be independent of worker support.
- For fall arrest, always keep anchor point above rear fall arrest attachment. If climbing above anchor point, attach to a new anchor point higher up. When anchor point to allow for connection above the fall arrest attachment device is not available, lanyard positioning must be such that free fall will be limited to a maximum of 6 feet and there will be no contact with a lower level.
- Never use an energy absorbing lanyard for positioning. Unit can open and extend which could result in a fall.
- Always attach the energy absorbing lanyard to the rear fall arrest attachment device included on the users equipment.
- Always visually check that: 1) each snap hook / carabiner freely engages D-ring or anchor point, 2) keeper / gate is completely closed with each use. **Never** rely solely on the feel or sound of a snap hook / carabiner engaging.
- Make sure each snap hook / carabiner is positioned so that its keeper / gate is **never** load bearing.
- Never use combinations of components or sub systems, or both, which may affect or interfere with the safe function of each other.
- Ensure there is no pressure on the snap hook locking mechanism sufficient to depress it as this will, due to its length, render it incompatible with currently designed rings and make it very susceptible to rollout.
- Never disable locking keeper / gate on snap hook / carabiner, punch holes in or alter a connecting device in any way.
- Avoid contact of this equipment with sharp edges, abrasive surfaces, high temperature surfaces, welding, or other heat sources, electrical hazards or moving machinery. When not in use, store to prevent exposure to the elements as well as over exposure to sunlight (U.V. degradation).
- Avoid contact of this equipment with chemicals that may damage the material. If in doubt, contact Buckingham Mfg. Co.
- This equipment is for personal use only, not towing or hoisting.
- **Never** work without independent fall arrest protection if there is danger of a fall.
- Always visually check that all buckles and snap hooks or carabiners are properly closed before use.
- Shoulder D-rings / attachments (optional) are intended for rescue / retrieval purposes only.
- Product covered under these instructions / warnings should not be resold / redistributed or re-used after use by original user

## INSPECTION

Inspection should occur prior to each use of the harness by the user and at a minimum of once a year by a competent person. Carefully inspect the harness for indications of wear, deterioration or impact loading. The inspection should include, but not be limited to, inspecting for:

- all leather strength components. If found, immediately cease use, discard and replace as product does not meet existing standards
- webbing cuts, kinks, abrasions, burns, excessive swelling, excessive wear, discoloration, cracks, charring, broken fibers, loose stitching, chemical or physical exposures and buckle holes in strap are not damaged
- loose, bent or pulled rivets, bent grommets, and broken, cut or burned threads
- tongue of buckle does not bind on buckle frame
- buckles with spring loaded slide type friction bars - slide bars work properly, are not binding, missing, deformed, bent, or otherwise damaged.
- nicks, cracks, distortion, excessive wear or corrosion of hardware (buckle, "D"-ring, etc.)
- check hook and loop fastener chest strap closure by adhering the hook and loop fastener securely together. When removing the hook from the loop, if there is little or no resistance, cease use and replace immediately. Hook and loop fastener will require a notable force to separate.

**NOTES:** Buckingham harnesses are equipped with an impact load indicator label that is designed to deploy upon arresting a fall.

An impact load will tear the thread exposing this label making the text legible. If you can read the text the harness has been impact loaded. If any evidence of wear, deterioration or impact loading as outlined is observed, immediately cease use, destroy the product and replace it with new equipment. Should any unusual conditions not outlined above be observed, or you have reasonable doubt about a particular condition, remove the equipment from service and notify your Supervisor, Safety Director or contact Buckingham Mfg. for clarification. Failure to carefully and completely inspect your equipment could result in serious injury or death.

## RAPPELLING LOOPS:

The harness rappelling loops (if equipped) shown in Figure 4 are to be used in pairs and are designed to have an ANSI Z359.12 rated carabiner connected directly to them for rappelling / rescue. Buckingham recommends using a triple action carabiner, such as our PN 50051 Steel carabiner, Figure. 5. When using the rappelling loops the user must ensure that the angle of the loops does not exceed 120°, Figure. 6 (when loaded the angle of the rappelling loops will decrease from what is noted when there is no load being applied). All directly connected components shall be compatible such that they perform as intended and cannot unintentionally disengage on their own during use of the system or during a fall event. Additionally, before each use, the user must inspect the rappelling loops to verify the wear guard is intact and there is no damage to the webbing or stitching



Figure 4



Figure 5



Figure 6

## Maintenance

- Proper maintenance and storage of your equipment will prolong its useful life and contribute toward its performance.
- Nylon and polyester webbing should be cleaned with water and mild soap (a dish washing soap that removes grease (i.e. Dawn)) and be allowed to dry thoroughly without using excessive heat.
- Hook and loop fastener of the chest strap closure is completely washable using the method described for nylon and polyester webbing. Additionally, it is dry cleanable. For best results mate fasteners before laundering or dry cleaning.
- The Quick Connect Buckle may be cleaned by using a cotton swab, limited air pressure or dipping it into a container of water to remove fine particles and any foreign matter which may enter the receptor end of the buckle and preventing proper engagement and function. The exterior of the buckle should be dried with a clean cloth. The inside of the receptor end of the buckle should be air-dried and re-lubricated.
- Additionally the Quick Connect Buckle pawls should be lubricated weekly or as often as required to maintain smooth operation (no binding) with a lightweight lubricant such as BuckLube, WD-40®, Etc. Wipe any excess lubricant off with a clean dry cloth.

## Rust on Harness Hardware

If through regular product inspection you note rust on hardware, the severity of the rust will determine whether the harness is deemed usable or unacceptable and recommended for removal from service. Below are examples of hardware rust exposure deemed acceptable for keeping the harness in service or unacceptable and recommended to cease use.

### Slight/Moderate (Acceptable): White Scale / Oxidation and Surface Rust

Single Slot



Slight

2 Slot



Slight

QC buckle



Moderate

Buckingham recommends cleaning hardware in this condition using an ultrafine Scotch Brite scouring pad (3M part number 14049 available at distributors such as Grainger), cut to approximately a 1" x 1" square, and with BuckLube, WD-40 Multi-Use Product or Hilco Lube lubricant cleaner (also available at retail distributors such as Grainger), scrub the areas that exhibit rust in a back and forth motion until all surface rust has been removed.

### Severe (Unacceptable): Pitting / Excessive Red Rust

Single Slot



Severe

2 Slot



Severe

QC buckle



Severe

Note: Hardware in this condition is recommended for removal from service.

**\*Dee rings are not shown above but shall follow the same Rust on Harness Hardware criteria as shown above\***

Please contact your Buckingham Customer Service Representative at 800-937-2825 should you have any questions as to condition of the hardware or your product.

## Storage

Storage areas should be clean, dry and free of exposure to corrosive elements, fumes, etc.

To aid in protecting the hardware from rusting, it is recommended that the hardware be treated with BuckLube, WD-40 Multi-Use Product or Hilco Lube lubricant cleaner at regular intervals.

Note: Also reference the used Inspection, Maintenance and Storage of Equipment Criteria of Annex A.

Properties of Full Body Harness (FBH) Materials

Material	Effect of Heat	Effect of Acids & Alkalis	Effect of Bleaches & Solvents	Resistance to Mildew, Aging, Sunlight, Abrasion
Polyester	Sticks at 440 to 445° F. Melts at 482° F.	Good resistance to most mineral acids. Dissolves with partial decomposition in concentrated solution of sulfuric acids. Good resistance to weak alkalis. Moderate resistance to strong alkalis at room temperature. Disintegrates in strong alkalis at boil.	Excellent resistance to bleaches & other oxidizing agents. Generally insoluble except in some phenolic compounds.	Not weakened by mildew. Excellent resistance to aging & abrasion. Prolonged exposure to sunlight causes some strength loss.
Nylon 6	Melts at 419 to 430° F. Slight discoloration at 300° F when held for 5 hr. Decomposes at 600 to 730° F.	Strong oxidizing agents & mineral acids cause degradation. Others cause loss in tenacity & elongation. Resists weak acids. Soluble in formic & sulfuric acids. Hydrolyzed by strong acids at elevated temperatures. Substantially inert in alkalis.	Can be bleached in most bleaching solutions. Generally insoluble in organic solvents. Soluble in some phenolic compounds.	Excellent resistance to mildew, aging & abrasion. Prolonged exposure to sunlight causes some degradation.
Nylon 6,6	Sticks at 445° F. Melts at 480° to 500° F. Yellows slightly at 300° F when held for 5 hr.	Unaffected by most mineral acids, except hot mineral acids. Dissolves with partial decomposition in concentrated solution of hydrochloric, sulfuric & nitric acids. Soluble in formic acid. Substantially inert in alkalis.	Can be bleached in most bleaching solutions. Generally insoluble in organic solvents. Soluble in some phenolic compounds.	Excellent resistance to mildew, aging & abrasion. Prolonged exposure to sunlight causes some deterioration.
Kevlar	Difficult to ignite. Does not propagate flame. Does not melt. Decomposes at about 900° F.	Good resistance to dilute acids and bases. Degraded by strong mineral acids and, to lesser extent, by strong mineral bases. Best chemical resistance from Kevlar 149.	Should not be bleached. Excellent solvent resistance.	Excellent resistance to mildew & aging. Prolonged exposure to sunlight causes deterioration, but fibers self-screening. Good abrasion resistance.
Nomex	Does not melt. Decomposes at 700° F.	Unaffected by most acids, except some strength loss after long exposure to hydrochloric, nitric & sulfuric. Generally good resistance to alkalis.	Unaffected by most bleaches & solvents except for slight strength loss from exposure to sodium chlorite.	Excellent resistance to mildew & aging. Prolonged exposure to sunlight causes some strength loss. Good abrasion resistance.

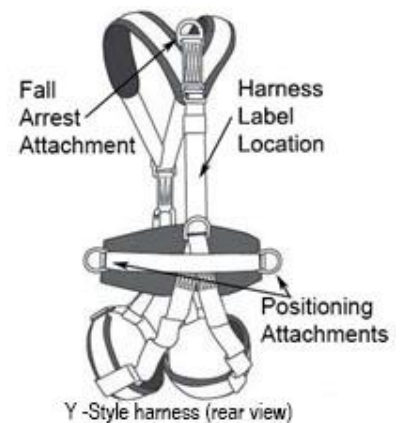
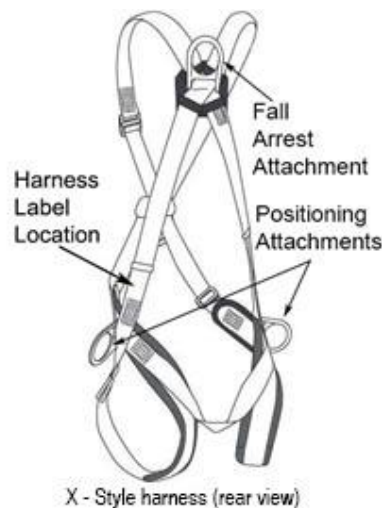
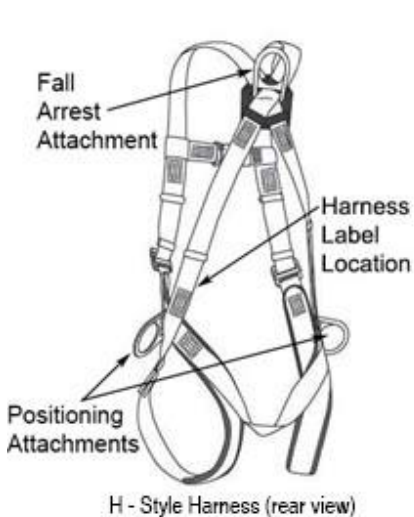



# FULL BODY HARNESS LABELS (not to scale)

- A- ANSI LABEL
- B- INSPECTION LABEL
- C- STANDARD HARNESS LABEL
- D- STANDARD HARNESS LABEL
- E- STANDARD HARNESS LABEL
- F- STANDARD HARNESS LABEL / ELECTRIC ARC TEST
- G- CSA PRODUCT LABEL
- H- ELECTRIC ARC TEST / CSA PRODUCT LABEL
- I- CSA HARNESS LABEL

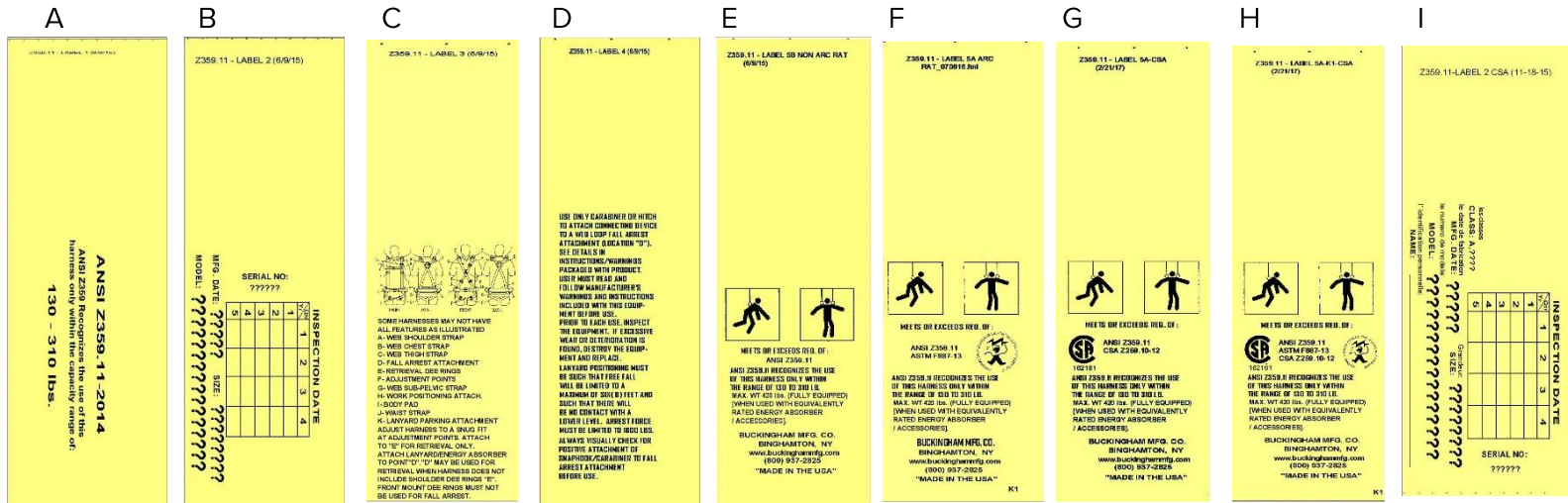

Impact Load Indicator Label

Lanyard Parking Attachment Element Label

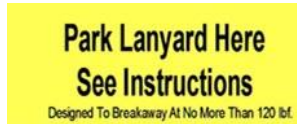

Should you have any questions regarding equipment manufactured by Buckingham Manufacturing Co., contact us at 1-800-937-2825.

## Typical Tower Harnesses

See Annex A sections 10 - 16 of this instruction for additional information regarding the location and use of various attachments that may be provided on this Harness.

### FRONT

### REAR

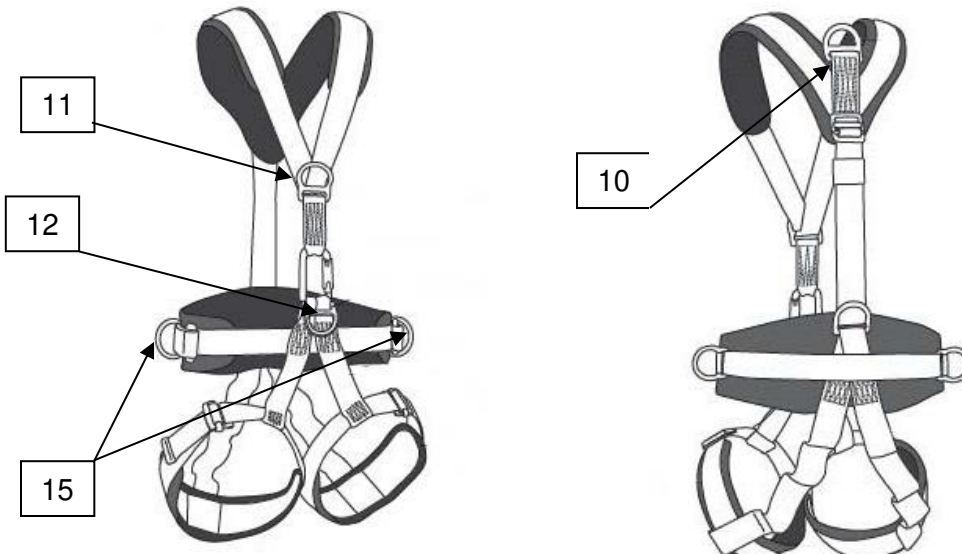

## FRONT

## REAR

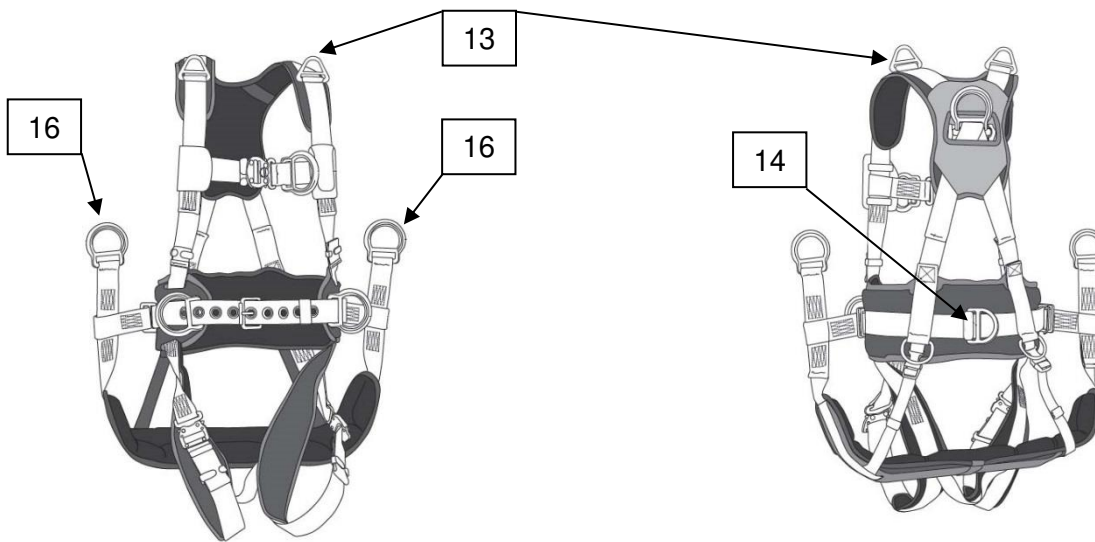

### Annex A

**Note: This information from the Z359.11 document is required to be included in the instruction manual for the end user:**  
ANSI/ASSE Z359 Requirements for Proper Use and Maintenance of Full Body Harnesses.

These are general requirements and information provided by ANSI/ASSE Z359, the Manufacturer of this equipment may impose more stringent restrictions on the use of the products they manufacture, see the Manufacturer's instructions.)

1. It is essential that the users of this type of equipment receive proper training and instruction, including detailed procedures for the safe use of such equipment in their work application. ANSI/ASSE Z359.2, *Minimum Requirements for a Comprehensive Managed Fall Protection Program*, establishes guidelines and requirements for an employer's managed fall protection program, including policies, duties and training; fall protection procedures; eliminating and controlling fall hazards; rescue procedures; incident investigations; and evaluating program effectiveness.
2. Correct fit of a Full Body Harness is essential to proper performance. Users must be trained to select the size and maintain the fit of their Full Body Harness.
3. Users must follow manufacturer's instructions for proper fit and sizing, paying particular attention to ensure that buckles are connected and aligned correctly, leg straps and shoulder straps are kept snug at all times, chest straps are located in the middle chest area, and leg straps are positioned and snug to avoid contact with the genitalia should a fall occur.
4. Full Body Harnesses which meet ANSI/ASSE Z359.11 are intended to be used with other components of a Personal Fall Arrest system that limit maximum arrest forces to 1800 pounds (8 kN) or less.
5. Suspension intolerance, also called suspension trauma or orthostatic intolerance, is a serious condition that can be controlled with good harness design, prompt rescue, and post fall suspension relief devices. A conscious user may deploy a suspension relief device allowing the user to remove tension from around the legs, freeing blood flow, which can delay the onset of suspension intolerance. An attachment element extender is not intended to be attached directly to an anchorage or anchorage connector for fall arrest. An energy absorber must be used to limit maximum arrest forces to 1800 pounds (8 kN). The length of the attachment element extender may affect free fall distances and free fall clearance calculations.
6. Full Body Harness (FBH) Stretch, the amount the FBH component of a Personal Fall Arrest system will stretch and deform during a fall, can contribute to the overall elongation of the system in stopping a fall. It is important to include the increase in fall distance created by FBH Stretch, as well as the FBH connector length, the settling of the user's body in the FBH, and all other contributing factors when calculating total clearance required for a particular fall arrest system.
7. When not in use, unused lanyard legs that are still attached to a Full Body Harness D-ring should not be attached to a work positioning element or any other structural element on the Full Body Harness unless deemed acceptable by the competent person and manufacturer of the lanyard. This is especially important when using some types of "Y" style lanyards, as some load may be transmitted to the user through the unused lanyard leg if it is not able to release from the harness. The lanyard parking attachment is generally located in the sternal area to help reduce tripping and entanglement hazards.
8. Loose ends of straps can get caught in machinery or cause accidental disengagement of an adjuster. All Full Body Harnesses shall include keepers or other components which serve to control the loose ends of straps.
9. Due to the nature of soft loop connections, it is recommended that soft loop attachments only be used to connect with other soft loops or carabiners. Snap hooks should not be used unless approved for the application by the manufacturer.

**Sections 10-16 provide additional information concerning the location and use of various attachments that may be provided on this FBH.**

**10. Dorsal** – The dorsal attachment element shall be used as the primary fall arrest attachment, unless the application allows the use of an alternate attachment. The dorsal attachment may also be used for travel restraint or rescue. When supported by the dorsal attachment during a fall, the design of the Full Body Harness shall direct load through the shoulder straps supporting the user, and around the thighs. Supporting the user, post fall, by the dorsal attachment will result in an upright body position with a slight lean to the front with some slight pressure to the lower chest. Considerations should be made when choosing a sliding versus fixed dorsal attachment element. Sliding dorsal attachments are generally easier to adjust to different user sizes, and allow a more vertical rest position post fall, but can increase FBH Stretch.

**11. Sternal** – The sternal attachment may be used as an alternative fall arrest attachment in applications where the dorsal attachment is determined to be inappropriate by a competent person, and where there is no chance to fall in a direction other than feet first. Accepted practical uses for a sternal attachment include, but are not limited to, ladder climbing with a guided type fall arrestor, ladder climbing with an overhead self-retracting lifeline for fall arrest, work positioning, and rope access. The sternal attachment may also be used for travel restraint or rescue.

When supported by the sternal attachment during a fall, the design of the Full Body Harness shall direct load through the shoulder straps supporting the user, and around the thighs. Supporting the user, post fall, by the sternal attachment will result in roughly a sitting or cradled body position with weight concentrated on the thighs, buttocks and lower back. Supporting the user during work positioning by this sternal attachment will result in an approximate upright body position.

If the sternal attachment is used for fall arrest, the competent person evaluating the application should take measures to ensure that a fall can only occur feet first. This may include limiting the allowable free fall distance. - It may be possible for a sternal attachment incorporated into an adjustable style chest strap to cause the chest strap to slide up and possibly choke the user during a fall, extraction, suspension, etc. The competent person should consider Full Body Harness models with a fixed sternal attachment for these applications.

**12. Frontal** – The frontal attachment serves as a ladder climbing connection for guided type fall arrestors where there is no chance to fall in a direction other than feet first, or may be used for work positioning. Supporting the user, post fall or during work positioning, by the frontal attachment will result in a sitting body position, with the upper torso upright, with weight concentrated on the thighs and buttocks. When supported by the frontal attachment the design of the Full Body Harness shall direct load directly around the thighs and under the buttocks by means of the sub-pelvic strap.

If the frontal attachment is used for fall arrest, the competent person evaluating the application should take measures to ensure that a fall can only occur feet first. This may include limiting the allowable free fall distance.

**13. Shoulder** – The shoulder attachment elements shall be used as a pair, and are an acceptable attachment for rescue, and entry/retrieval. The shoulder attachment elements shall not be used for fall arrest. It is recommended that the shoulder attachment elements be used in conjunction with a yoke which incorporates a spreader element to keep the Full Body Harness shoulder straps separate.

**14. Waist, Rear** – The waist, rear attachment shall be used solely for travel restraint. The waist, rear attachment element shall not be used for fall arrest. Under no circumstances is it acceptable to use the waist, rear attachment for purposes other than travel restraint. The waist, rear attachment shall only be subjected to minimal loading through the waist of the user, and shall never be used to support the full weight of the user.

**15. Hip** – The hip attachment elements shall be used as a pair, and shall be used solely for work positioning. The hip attachment elements shall not be used for fall arrest. Hip attachments are often used for work positioning by arborists, utility workers climbing poles, and construction workers tying rebar and climbing on form walls. Users are cautioned against using the hip attachment elements (or any other rigid point on the Full Body Harness) to store the unused end of a fall arrest lanyard, as this may cause a tripping hazard, or, in the case multiple leg lanyards, could cause adverse loading to the Full Body Harness and the wearer through the unused portion of the lanyard.

**16. Suspension seat** - The suspension seat attachment elements shall be used as a pair, and shall be used solely for work positioning. The suspension seat attachment elements shall not be used for fall arrest. Suspension seat attachments are often used for prolonged work activities where the user is suspended, allowing the user to sit on the suspension seat formed between the two attachment elements. An example of this use would be window washers on large buildings.

#### USER INSPECTION, MAINTENANCE AND STORAGE OF EQUIPMENT

Users of personal fall arrest systems shall, at a minimum, comply with all manufacturer instructions regarding the inspection, maintenance and storage of the equipment. The user's organization shall retain the manufacturer's instructions and make them readily available to all users. See **ANSI/ASSE Z359.2, Minimum Requirements for a Comprehensive Managed Fall Protection Program** regarding user inspection, maintenance and storage of equipment.

**1.** In addition to the inspection requirements set forth in the manufacturer's instructions, the equipment shall be inspected by the user before each use and, additionally, by a competent person, other than the user, at interval of no more than one year for:

- Absence or illegibility of markings;
- Absence of any elements affecting the equipment form, fit or function;
- Evidence of defects in or damage to hardware elements including cracks, sharp edges, deformation, corrosion, chemical attack, excessive heating, alteration and excessive wear.

- Evidence of defects in or damage to strap or ropes including fraying, unsplicing, unlaying, kinking, knotting, roping, broken or pulled stitches, excessive elongation, chemical attack, excessive soiling, abrasion, alteration, needed or excessive lubrication, excessive aging and excessive wear.

**2.** Inspection criteria for the equipment shall be set by the user's organization. Such criteria for the equipment shall equal or exceed the criteria established by this standard or the manufacturer's instructions, whichever is greater.

**3.** When inspection reveals defects in, damage to, or inadequate maintenance of equipment, the equipment shall be permanently removed from service or undergo adequate corrective maintenance, by the original equipment manufacturer or their designate, before return to service.

#### Maintenance and Storage

**1.** Maintenance and storage of equipment shall be conducted by the user's organization in accordance with the manufacturer's instructions. Unique issues, which may arise due to conditions of use, shall be addressed with the manufacturer.

**2.** Equipment which is in need of, or scheduled for maintenance shall be tagged as "unusable" and removed from service.

**3.** Equipment shall be stored in a manner as to preclude damage from environmental factors such as temperature, light, UV, excessive moisture, oil, chemicals and their vapors or other degrading elements.

NOTE: Ensure proper fit / size of product before use. This product **cannot** be returned unless it is in new / unused condition.

### **BUCKINGHAM MFG.**

BINGHAMTON, NY

1-800-937-2825

[www.buckinghammfg.com](http://www.buckinghammfg.com)

Information contained in these written instructions supersedes all other information (written, audio, video etc.) produced by Buckingham Mfg. prior to the revision date of this document.